

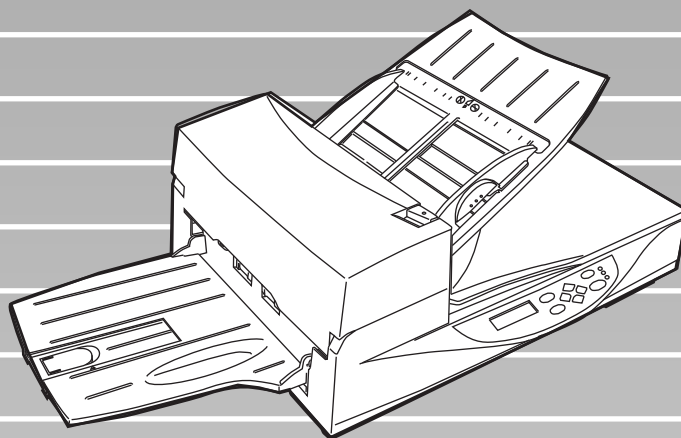

P3PC-E832-01EN

# ***fi-4340C Image Scanner***

## *Operator's Guide*



**FUJITSU**



# Revisions, Disclaimers

Edition	Date published	Revised contents
01	October, 2001	First edition
Specification No. P3PC-E832-01ENC2		

**FCC declaration:** This equipment has been tested and found to comply with the limits for a Class B digital device, pursuant to Part 15 of the FCC Rules. These limits are designed to provide reasonable protection against harmful interference in a residential installation. This equipment generates, uses, and can radiate radio frequency energy and, if not installed and used in accordance with the instruction manual, may cause harmful interference to radio communications. However, there is no guarantee that interference will not occur in a particular installation. If this equipment does cause harmful interference to radio or television reception, which can be determined by turning the equipment off and on, the user is encouraged to try to correct the interference by one or more of the following measures:

- Reorient or relocate the receiving antenna.
- Increase the separation between the equipment and receiver.
- Connect the equipment into an outlet on a circuit different from that to which the receiver is connected.
- Consult the dealer or an experienced radio/TV technician for help.

**FCC warning:** Changes or modifications not expressly approved by the party responsible for compliance could void the user’s authority to operate the equipment.

 **NOTICE**

- The use of a non-shielded interface cable with the referenced device is prohibited. The length of the parallel interface cable must be 3 meters (10 feet) or less. The length of the serial interface cable must be 15 meters (50 feet) or less.
- The length of the power cord must be 3 meters (10 feet) or less.

This Class B digital apparatus complies with Canadian ICES-003.

Cet appareil numérique de la classe B est conforme à la norme NMB-003 du Canada.

## ■ **Bescheinigung des Herstellers / Importeurs**

Hiermit wird bescheinigt, daß *der/dieses*

- fi-4340C in Übereinstimmung mit den Bestimmungen der
- AmtsblVfg 243/1991 funktionsstört ist. Der Deutschen Bundespost wurde das Inverkehrbringen dieses Gerätes angezeigt und die Berechtigung zur Überprüfung der Serie auf Einhaltung der Bestimmungen eingeräumt.
- Maschinenlärminformationsverordnung 3. GS GV, 18.01.1991: Der höchste Schalldruckpegel beträgt 70 dB (A) oder weniger gemäß ISO/7779.

As an ENERGYSTAR® Partner, PFU Limited has determined that this scanner meets ENERGYSTAR® guidelines for energy efficiency. ENERGYSTAR® is a U. S. registered mark.

## ■ **Use in Enhanced Safety Applications**

This Product is designed, developed and manufactured as contemplated for general use, including without limitation, general office use, personal use, household use, and ordinary industrial use, but is not designed, developed and manufactured as contemplated for use accompanying fatal risks or dangers that, unless extremely high safety is secured, could lead directly to death, personal injury, severe physical damage or other loss (hereinafter "High Safety Required Use"), including without limitation, nuclear reaction control in nuclear facility, aircraft flight control, air traffic control, mass transport control, medical life support system, missile launch control in weapon system. You shall not use this Product without securing the sufficient safety required for the High Safety Required Use. If you wish to use this Product for High Safety Required Use, please consult with our sales representatives in charge before such use.

The manufacturers accept no claims from customers or third parties in relation to, and accepts no responsibility for losses incurred as a result of, the use of this product in enhanced safety applications.

## ■ **Copying**

Copying of paper money, coins, securities and passports issued by government authorities, licenses and permits issued by public authorities and private organizations, official documents, and private documents etc. is illegal and is subject to punishment.

---

## ■ Copyright

Copyrighted items such as books, paintings, prints, maps, drawings, and photographs may be copied only for private or home use, or for similar applications. Copying for other applications without the consent of the holder of the copyright is illegal.

## ■ Trademarks and Registered Trademarks

Microsoft®, Windows® and Windows® NT are registered trademarks of the Microsoft Corporation in the United States of America and in other countries. ISIS® is the registered trademark of Pixel Translations, a division of Actionpoint Inc. Names of other goods and products occurring in this manual are the registered trademarks or trademarks of the relevant company.

The contents of this manual may be revised without prior notice.

All Rights Reserved, Copyright © 2001 PFU LIMITED.

Printed in Japan.

No part of this manual may be reproduced in any form without permission.

# Fujitsu Group Offices

---

Please send your comments on this manual or on Fujitsu products to the following addresses:

## **FUJITSU COMPUTER PRODUCTS OF AMERICA, INC.**

2904 Orchard Parkway, San Jose,  
California CA95134-2009, U.S.A.

Phone: (1-800)591-5924;  
(1-408)432-6333

Technical Assistance Center:  
(1-800)626-4686

Fax: (1-408)894-1709

Website: <http://www.fcpa.com/>

E-mail: [info@fcpa.fujitsu.com](mailto:info@fcpa.fujitsu.com)

## **FUJITSU EUROPE LTD.**

Hayes Park Central, Hayes End Road,  
Hayes Middlesex UB4 8FE, England

Phone: (44-208)573-4444

Fax: (44-208)573-2643

Website:  
<http://www.fujitsu-europe.com/home/>

E-mail: [iwebmaster@fujitsu-europe.com](mailto:iwebmaster@fujitsu-europe.com)

## **FUJITSU NORDIC AB**

Kung Hans Vag 12, S-192 68  
Sollentuna, Sweden

Phone: (46-8)626-45-00

Fax: (46-8)626-45-88

Website:  
<http://www.fujitsu-europe.com/home/>

## **FUJITSU FRANCE S.A.**

1, Place des Etats-Unis, Silic 310,  
94588 Rungis Cedex, France

Phone: (33-1)41-80-38-88

Fax: (33-1)41-80-3850

Website:  
<http://www.fujitsu-europe.com/home/>

## **FUJITSU CANADA, INC.**

2800 Matheson Boulevard East,  
Mississauga, Ontario L4W 4X5, Canada

Phone: (1-905)602-5454

Fax: (1-905)602-5457

Website: <http://www.fujitsu.ca/>

E-mail: [imaging@fujitsu.ca](mailto:imaging@fujitsu.ca)  
(For Sales Questions)

[scantech@fujitsu.ca](mailto:scantech@fujitsu.ca)  
(For technical questions)

## **FUJITSU DEUTSCHLAND GMBH.**

Frankfurter Ring 211, 80807 Munchen  
40, Germany

Phone: (49-89)323-78-0

Fax: (49-89)323-78-100

Website: <http://www.fujitsu.de/>

E-mail: [webmaster@fujitsu.de](mailto:webmaster@fujitsu.de)

## **FUJITSU ITALIA S.p.A.**

Via Nazario Sauro, 38  
20099 Sesto San Giovanni (Milan), Italy

Phone: (39-02)26294-1

Fax: (39-02)26294-201

Website:  
<http://www.fujitsu-europe.com/home/>

## **FUJITSU ICL ESPAÑA, S.A.**

Camino Cerro de los Gamos, 1 28224,  
Pozuelo de Alarcon, Madrid, Spain

Phone: (34-91)784-9000

Fax: (34-91)784-9317

Website:  
<http://www.fujitsu-europe.com/home/>

E-mail: [imagemaster@mail.fujitsu.es](mailto:imagemaster@mail.fujitsu.es)

**FUJITSU AUSTRALIA LTD**

2 Julius Avenue  
North Ryde, N.S.W 2113 Australia  
Phone: (61-2)9776-4555  
Fax: (61-2)9776-4556  
CompuServe: GO FUJITSU  
Website: <http://www.fujitsu.com.au/>

**FUJITSU TAIWAN LTD.**

19th Fl., No39, 1 Sec. chung-Hwa Rd.,  
Taipei, Taiwan R.O.C.  
Phone: (886-2)2311-2255  
Fax: (886-2)2311-2277

**FUJITSU SYSTEMS BUSINESS  
(THAILAND) LTD.**

12th Fl., Olympia Thai Tower, 444  
Rachadapisek Road, Samsennok,  
Huay kwang, Bangkok 10320, Thailand  
Phone: (662)512-6066  
Fax: (662)512-6068

**FUJITSU SYSTEMS BUSINESS  
(MALAYSIA) SDN, BHD.**

Fujitsu Plaza 1A, Japan Tandang 204,  
P.O.Box 636, Jalan Sultan, 46770,  
Petaling Jaya Selangor Darul  
Ehsan, Malaysia  
Phone: (60-3)793-3888  
Fax: (60-3)7783-0888

**Computer Products Business Group**

658-1 Tsuruma Machida-shi, Tokyo  
194-8510, Japan  
Phone: (81-42)796-5211  
Fax: (81-42)788-7651  
Website: <http://www.pfu.fujitsu.com/>  
E-mail: [scanners@pfu.fujitsu.com](mailto:scanners@pfu.fujitsu.com)

**FUJITSU COMPUTER (SINGAPORE)  
PTE.LTD.**

20 Science Park Road, #03-01, Tele  
Teck Park Singapore Science Park II,  
Singapore 117674  
Phone: (65)777-6577  
Fax: (65)771-5499  
Website:  
<http://www.fujitsu-computers.com.sg>  
E-mail: [inquiry@fcs1.fujitsu.com.sg](mailto:inquiry@fcs1.fujitsu.com.sg)

**FUJITSU HONG KONG LTD.**

10/F., Lincoln House, 979 King's Road,  
Taikoo Place, Island East, Hong Kong  
Phone: (852)2827-5780  
Fax: (852)2827-4724  
E-mail: [scanner@fujitsu.com.hk](mailto:scanner@fujitsu.com.hk)

**FUJITSU KOREA LTD.**

5-11 Fl., Coryo Finance Center Building,  
Youido-Dong 23-6, Young DungPo-gu,  
Seoul, Korea, 150-010  
Phone: (82-2)3787-5970  
Fax: (82-2)3787-6070  
Website: <http://www.fujitsu.co.kr>  
E-mail: [webmaster@fkl.fujitsu.co.kr](mailto:webmaster@fkl.fujitsu.co.kr)

**FUJITSU PHILIPPINES, INC**

2nd Fl., United Life Building, Pasay  
Road, Legaspi Village Makati,  
Metro Manila, Philippines  
Phone: (63-2)812-4002  
Fax: (63-2)817-7576

**Corporate headquarters**

Nu 98-2 Unoke, Unoke-machi,  
kahoku-gun, Ishikawa 929-1192, Japan  
Phone: (81-76)283-1212  
Fax: (81-76)283-4689

## Note, Liability

---

READ ALL OF THIS MANUAL CAREFULLY BEFORE USING THIS PRODUCT. IF NOT USED CORRECTLY, UNEXPECTED INJURY MAY BE CAUSED TO USERS OR BYSTANDERS.

While all efforts have been made to ensure the accuracy of all information in this manual, PFU assumes no liability to any party for any damage caused by errors or omissions or by statements of any kind in this manual, its updates or supplements, whether such errors are omissions or statements resulting from negligence, accidents, or any other cause. PFU further assumes no liability arising from the application or use of any product or system described herein; nor any liability for incidental or consequential damages arising from the use of this manual. PFU disclaims all warranties regarding the information contained herein, whether expressed, implied, or statutory.

PFU reserves the right to make changes to any products herein, to improve reliability, function, or design, without further notice and without obligation.



# Preface

---

This manual explains how to use the fi-4340C image scanner.

This manual contains chapters on the following topics:

COMPONENTS  
INSTALLATION AND CONNECTIONS  
HOW TO INSTALL THE DEVICE DRIVER  
OPERATING INSTRUCTIONS  
ADF DOCUMENT SPECIFICATION  
OPERATOR PANEL MESSAGE  
SETUP MODE  
TROUBLESHOOTING  
CONSUMABLES AND OPTIONS  
SCANNER SPECIFICATIONS

It also contains a Glossary of Terms and an Index.

Refer to the Cleaning and Maintenance Guide for information about the routine operation of the fi-4340C.

The Cleaning and Maintenance Guide contains chapters on OPERATING INSTRUCTIONS, CLEANING, REPLACEMENT OF PARTS, ADJUSTMENT and TROUBLESHOOTING.

The fi-4340C is a very fast and highly functional color image scanner developed for high quality color image processing, using charge-coupled device (CCD) color image sensors. This scanner features high-speed duplex scanning with an automatic document feeder (ADF).

# Conventions

---

Important information that requires special attention is indicated as follows:

 **WARNING**

WARNING indicates that serious personal injury may result if you do not follow a procedure correctly.

 **CAUTION**

CAUTION indicates that minor personal injury, loss of data, or damage to the scanner may result if you do not follow a procedure correctly.

 **NOTICE**

A NOTICE provides “how-to” tips or suggestions to help you perform a procedure correctly.

# Precautions

---

This section describes precautions to follow when installing the scanner.

To ensure the longevity and proper functioning of your scanner, do not install the scanner in the places and environments described below.

## ■ Warning

Important warnings employed in this manual are as follows.

---

### Do not damage the power cable.



Damage to the power cable may result in fire or electric shock.

Do not place heavy objects on, pull, tightly bend, twist, heat, or modify the power cable.

Do not use the power cable or socket if it is damaged, or if the plug is loose in the socket.

---

### Use only the specified power cable or extension cable.



Use only the specified power cable or extension cable. Use of other cables may result in electric shock or malfunction.

---

### Use only at the specified voltage. Ensure that too many cables are not connected to the same socket.



Use at other than the specified voltage may result in fire or electric shock.

Ensure that too many cables are not connected to the same socket.

---

### Wipe all dust from plug on the power supply cable.



Using a dry cloth, remove all dust on the metal components of the plug, and on all surfaces to which the metal components are attached.

Presence of dust may result in fire or electric shock.

---

**Do not use the equipment in areas with high levels of oil smoke, steam, humidity, or dust.**



Installation in areas with high levels of oil smoke, steam, humidity, or dust may result in fire or electric shock.

---

**Do not use the equipment if an abnormal smell is apparent.**



If the equipment overheats, emits smoke or abnormal smells, or makes abnormal noises, switch power OFF immediately and remove the power plug from the socket.

Check that smoke is no longer emitted, and call your dealer or maintenance service center. Do not attempt to repair the equipment yourself under any circumstances.

---

**Ensure that water or foreign matter does not enter the equipment.**



Do not insert or drop metal objects or combustible objects into openings (eg. ventilation openings).



Ensure that liquids (eg. coffee) and metal objects (eg. paper clips) do not enter the equipment.



Do not spill or leak water onto the equipment.



If foreign matter (eg. water, other liquids, metal objects) enters the equipment, switch power OFF immediately and remove the power plug from the socket, and call your dealer or maintenance service center. Particular care is required if children are in the vicinity.



---

**Do not open the equipment without good reason.**

Dismantlement



The equipment contains high-voltage components, and should not be dismantled or modified.

---

**Always remove the plug from the socket before fitting or removing optional equipment.**

Electric shock



Switch the equipment power supply OFF, and remove the plug from the socket, before fitting or removing optional equipment in accordance with the specified procedure.

Do not



Grip the plug to remove the power cable from the socket.

---

**Do not move the equipment alone.**

Do



Never move the equipment alone.

---

**Switch power OFF if the equipment is damaged.**

Plug



If the equipment is dropped, or covers etc. have been damaged, switch power supply OFF, remove the plug from the socket, and call your dealer or maintenance service center.

---

**Do not place in wet areas.**

Electric shock



Do not place the scanner where liquid spills may occur.

## ■ Caution

Important cautions employed in this manual are as follows.

---

### **Do not touch the power cable with wet hands.**

Electric shock



Do not remove or insert the plug with wet hands. Wet hands may result in electric shock.

---

### **Earth the equipment.**

Grounding



This equipment must be earthed. Always connect the power cable to a 3-pin socket. If earthing is not possible, call your dealer or maintenance service center.

---

### **Always ensure that the equipment is installed in the stable location.**

Do



Ensure that no part of the scanner is liable to fall from the desk, and that the base of the equipment is level.

Do not



Ensure that the equipment is installed in a stable location. The equipment should be installed in a location which is level and subject to minimal vibration.

---

### **Insert the power plug fully into the socket.**

Do



Ensure that the power plug is inserted as far as possible into the socket.

---

### **Do not block the ventilation openings.**

Do not



If the ventilation openings are blocked the interior of the equipment will overheat, and may result in fire or malfunction.

---

**Do not place heavy objects on, and do not stand on, the equipment.**



Placing heavy objects on the equipment, or standing on the equipment while working, may result in injury.

---

**Remove the power plug from the socket before moving the equipment.**



Moving the equipment with the cable connected may result in damage to the cable, fire or electric shock, or injury. Always remove the power plug from the socket, and disconnect extension cables, before moving the equipment.

Always clear the floor before beginning work.

---

**Avoid static electricity.**



Ensure that the equipment is installed away from strong magnetic fields, sources of electrical noise and air flow.

If the scanner is used near an air conditioner, copying machine, or TV set, the scanner may operate incorrectly.

Avoid static electricity. Static electricity may be a cause of mis-operation of the equipment. Ensure that the floor and desk on which the equipment is installed is of a material which does not generate static electricity.

---

**Ensure that clothing, ties, and hair do not become caught in gears and rollers.**



Clothing, ties, and hair becoming caught in moving components such as gears and rollers may result in injury.

---

**Remove the power plug from the socket if the equipment is to be out of use for a considerable length of time.**



For safety reasons, the power plug should be removed from the socket if the equipment is to be out of use for a significant time.

---

**Remove the power cable from the socket immediately thunder is heard.**



Remove the power cable from the socket if thunder is heard nearby. The equipment may be damaged if it remains connected during an electrical storm.

---

**Do not leave the equipment in direct sunlight.**



Leaving the equipment in direct sunlight or in the vicinity of air-conditioning equipment will result in the internal temperature of the equipment increasing, and may result in fire or malfunction.

Ensure that the equipment is installed in a well ventilated area.



# CONTENTS

<b>❑ CHAPTER 1 COMPONENTS</b>	
Checking the Components .....	1-2
Units and Assemblies .....	1-3
Operator Panel .....	1-6
<b>❑ CHAPTER 2 INSTALLATION AND CONNECTIONS</b>	
Confirm of the Manufacturing Labels .....	2-2
Placing the scanner .....	2-3
<b>❑ CHAPTER 3 HOW TO INSTALL THE DEVICE DRIVER</b>	
Procedure .....	3-2
<b>❑ CHAPTER 4 OPERATING INSTRUCTIONS</b>	
Turning the Power On .....	4-2
Waking up the Scanner from the Low Power Mode .....	4-3
Manual Feed Mode Setting .....	4-4
Loading Documents on the ADF .....	4-5
Loading Documents on the Document bed .....	4-9
Loading Documents Larger than the Document bed .....	4-10
Reading a Page from a Thick Book .....	4-11
Clearing Paper Jams .....	4-12
<b>❑ CHAPTER 5 ADF DOCUMENT SPECIFICATION</b>	
Document Size .....	5-2
Document Quality .....	5-3
ADF Document Feeder Capacity .....	5-5
Areas not to be Perforated .....	5-6
Grounding Color Areas .....	5-7
Double Feed Detection Condition .....	5-8
Job Separation Sheet .....	5-9
<b>❑ CHAPTER 6 OPERATOR PANEL MESSAGE</b>	
Counter Display .....	6-2
Operation status .....	6-3
Temporary error .....	6-4
Alarm .....	6-5
<b>❑ CHAPTER 7 SETUP MODE</b>	
Activating the Setup Mode .....	7-2
Contents of the Setup Mode .....	7-3
<b>❑ CHAPTER 8 TROUBLESHOOTING</b>	
Troubleshooting .....	8-2
<b>❑ CHAPTER 9 CONSUMABLES AND OPTIONS</b>	
Consumables .....	9-2
Options .....	9-3
VIDEO INTERFACE BOARD .....	9-4
IPC-4D(IMAGE PROCESSING CIRCUIT BOARD) .....	9-9
fi-434PR(IMPRINTER) .....	9-10

fi-CMP3(JPEG COMPRESSION BOARD) .....	9-11
<b>❑ CHAPTER 10 SCANNER SPECIFICATIONS</b>	
Basic Product Specification .....	10-2
Installation Specification .....	10-3
Dimensions .....	10-4
<b>❑ GLOSSARY OF TERMS</b> .....	GL-1
<b>❑ INDEX</b> .....	IN-1

**CHAPTER 1**

**COMPONENTS**

COMPONENTS

**CHAPTER 2**

**INSTALLATION AND CONNECTIONS**

INSTALLATION AND CONNECTIONS

**CHAPTER 3**

**HOW TO INSTALL THE DEVICE DRIVER**

HOW TO INSTALL THE DEVICE DRIVER

**CHAPTER 4**

**OPERATING INSTRUCTIONS**

OPERATING INSTRUCTIONS

**CHAPTER 5**

**ADF DOCUMENT SPECIFICATION**

ADF DOCUMENT SPECIFICATION

**CHAPTER 6**

**OPERATOR PANEL MESSAGE**

OPERATOR PANEL MESSAGE

**CHAPTER 7**

**SETUP MODE**

SETUP MODE

**CHAPTER 8**

**TROUBLESHOOTING**

TROUBLESHOOTING

**CHAPTER 9**

**CONSUMABLES AND OPTIONS**

CONSUMABLES AND OPTIONS

**CHAPTER 10**

**SCANNER SPECIFICATIONS**

SCANNER SPECIFICATIONS

**GLOSSARY OF TERMS**

GLOSSARY OF TERMS

**INDEX**

INDEX

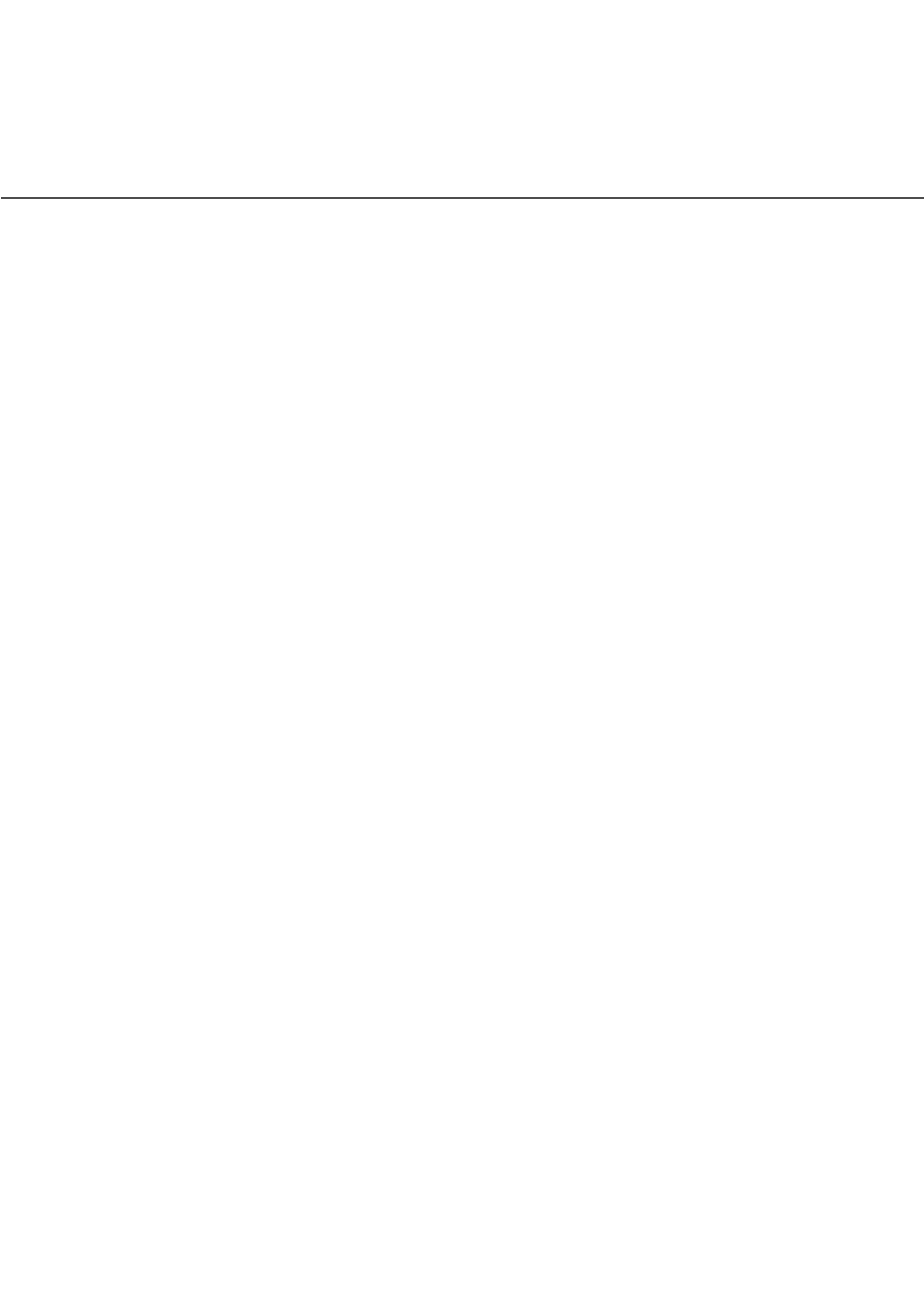

# COMPONENTS

---

*This chapter describes checking the Components, Units and Assemblies of the scanner, and operator panel arrangement, and the function of parts.*

Checking the Components .....	1-2
Units and Assemblies .....	1-3
Operator Panel.....	1-6

# Checking the Components

These high precision components must be handled carefully.  
Confirm that all the components shown in the following figure have been received.  
If any component is missing, please contact your sales agent.

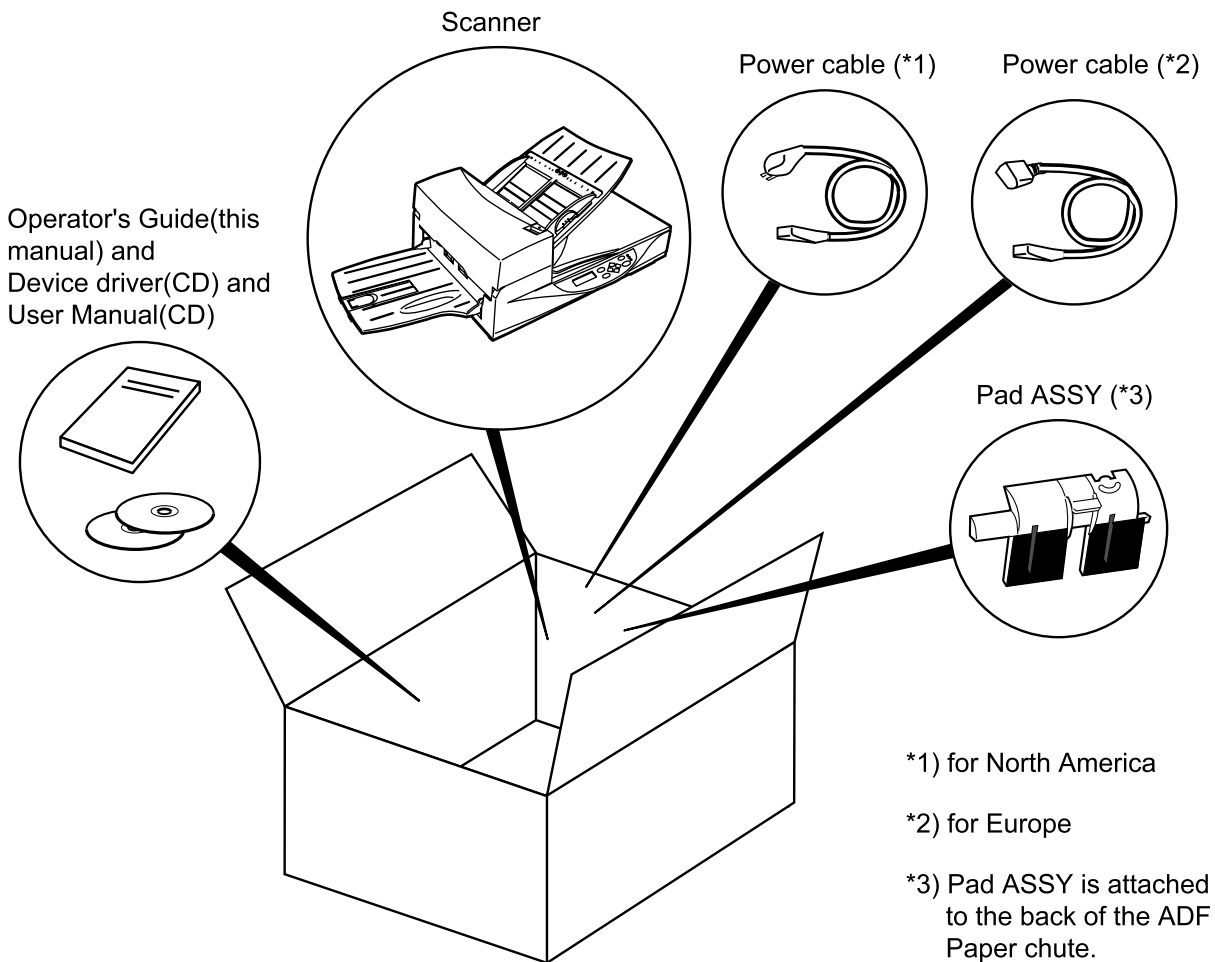

## NOTICE

The CD-ROMs contains "Cleaning and Maintenance" and this manual.

# Units and Assemblies

This section shows the exterior view and assemblies of the scanner. This section also provides the name of each part and describes its functions.

## ■ Units

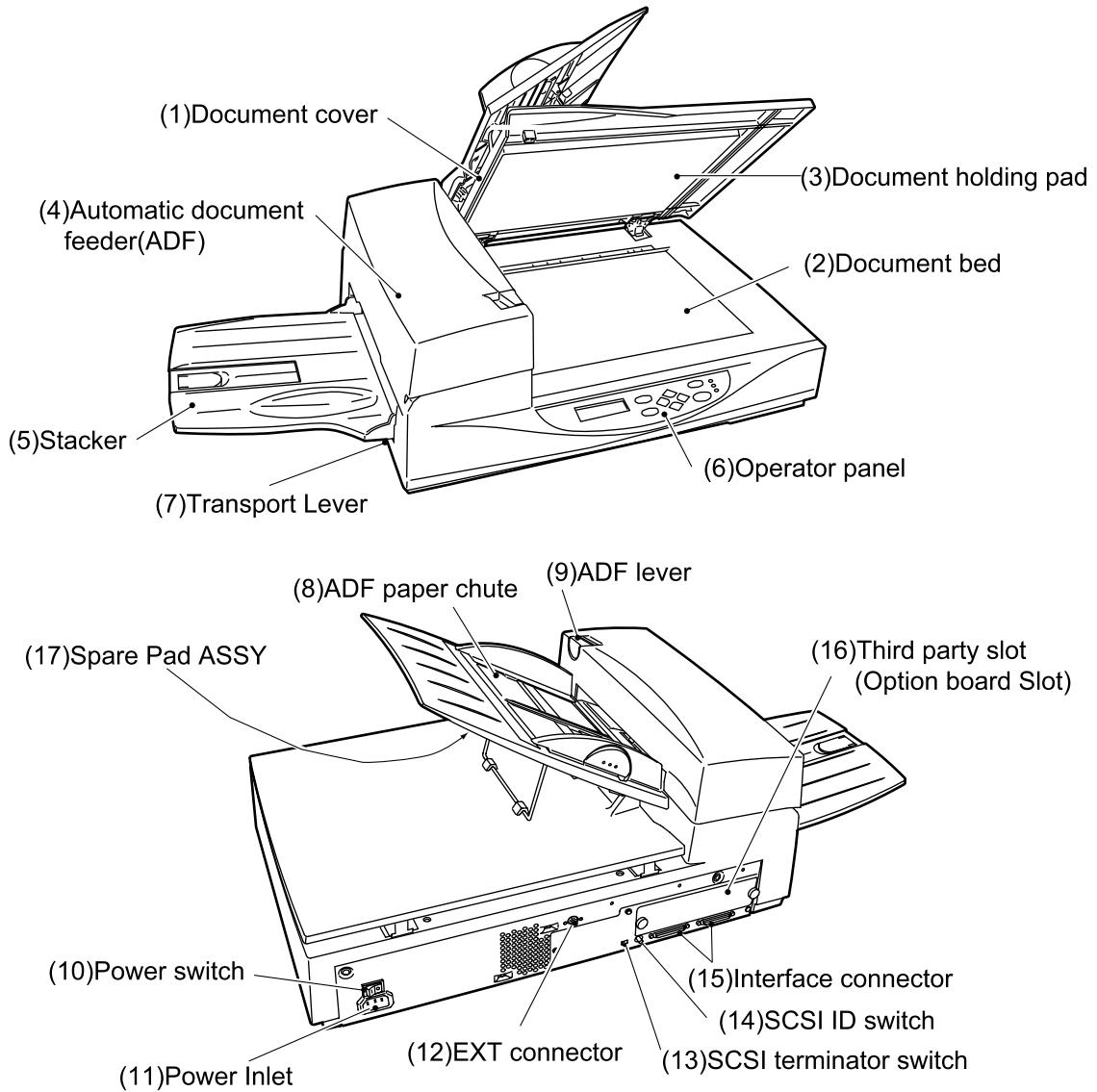

### NOTICE

The transport lever should be switched to the operating position when the scanner is to be used. Refer to Chapter2 "Placing the Transport Lever (page 2-3)" for details.

No .	Part	Function
1	Document cover	Closes over and keeps in place the document to be read.
2	Document bed	Holds document to be read. Also called Flatbed (FB).
3	Document holding pad	Presses document to the Document bed.
4	Automatic document feeder (ADF)	Automatically feeds documents to the reading position.
5	Stacker	Stacks the read documents.
6	Operator panel	Contains indicator panel that indicates scanner status.
7	Transport Lever	Transport lever Secures the carrier unit. Set to locked position when moving scanner.
8	ADF paper chute	Holds the documents to be fed by the automatic document feeder (ADF).
9	ADF lever	Opens/closes the ADF to enable the removal of documents jammed in the feeder.
10	Power switch	Turns the power On or Off.
11	Power inlet	Connects to an AC power outlet with the power cable.
12	EXT connector	Connects to an optional imprinter.
13	SCSI terminator switch	Set to ON when the image scanner is the final device on the SCSI daisy chain. Otherwise, set to OFF.
14	SCSI-ID switch	Sets the SCSI ID. (Default ID is 5.)
15	Interface connectors	Connect to the host system with interface cables.
16	Third party slot	A Fujitsu VIDEO INTERFACE BOARD or fi-CMP3(JPEG COMPRESSION BOARD) is installed.
17	Spare Pad ASSY	Spare pad assembly. (One spare pad assembly is provided as the default setting.)



■ Assemblies

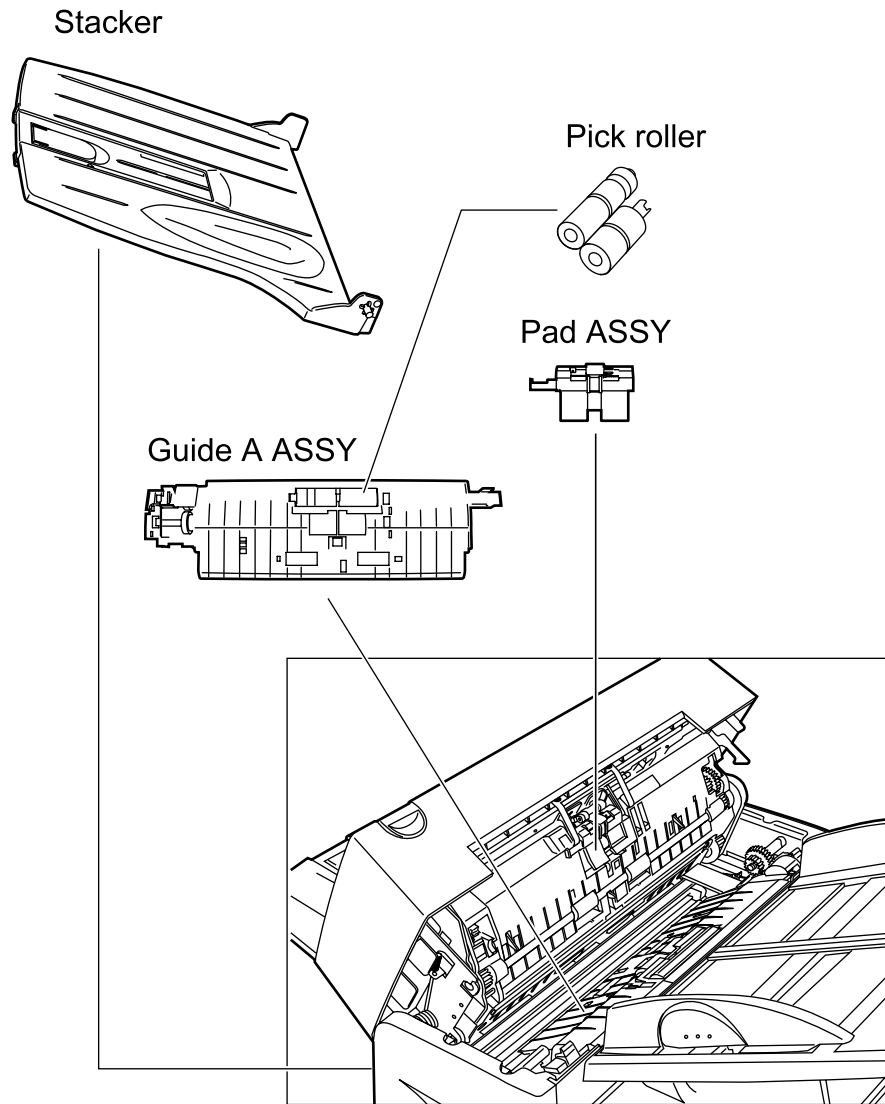

# Operator Panel

The operator panel is located on the upper right hand side of the scanner. The panel consists of an LCD display (16 characters x 2 lines), LEDs and buttons.

## ■ Arrangement

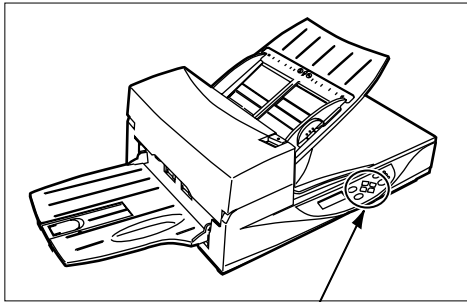



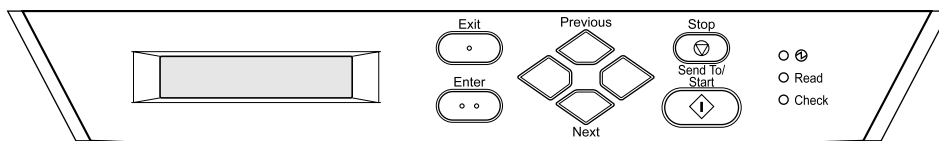

Operator panel

Operator panel



## ■ Button and LED

Name of the button and LED		Function
Button	Next 	Displays the next LCD screen.
	Previous 	Displays the previous LCD screen.
		Moves the cursor to the left.
		Moves the cursor to the right.
	Exit	When you are entering settings on the Operator panel, pressing this button returns you immediately to the Scanner Ready screen.
	Enter	Enters the parameter currently selected by the cursor.
	Send To/ Start	Operational only when Manual start mode is set or the Read lamp lights; Starts the reading when video interface option is used. Some application software packages make use of this button.
	Stop	When the Check LED lights, pressing this button releases the error status (turns off Check and returns to the Scanner Ready screen). Operational only during the reading operation; stops the reading when the video interface option is used. Also turns off the Check lamp.
LED		Indicates that the scanner is On.
	Read	Indicates the scanner is reading or ready to read.
	Check	If lit, this indicates that an alarm occurred. Pressing the Stop button turns the Check lamp Off. If it blinks at one second intervals, this means that a jam or double feed has been detected. If the problem is jammed paper, removing the jammed paper turns off the Check lamp. If the problem is double feed, pressing the Stop button turns off the Check lamp. If it blinks at four seconds intervals, this means that cleaning the ADF is necessary.



# ***INSTALLATION AND CONNECTIONS***

---

*The chapter describes how to install and connect the scanner.*

**Confirm of the Manufacturing Labels.....2-2**

**Placing the scanner.....2-3**

# Confirm of the Manufacturing Labels

This section describes how to check the labels.

Position of two labels

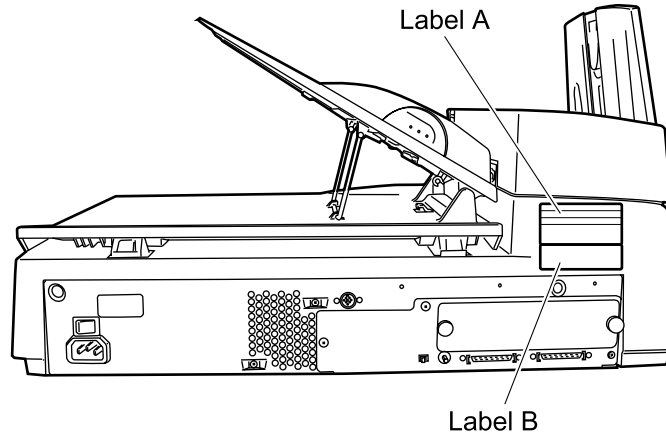

Label A (Example; your actual label may differ)

Indicates regulations and standards to which this scanner conforms.



Label B (Example; your actual label may differ)

Indicates product information as follows:

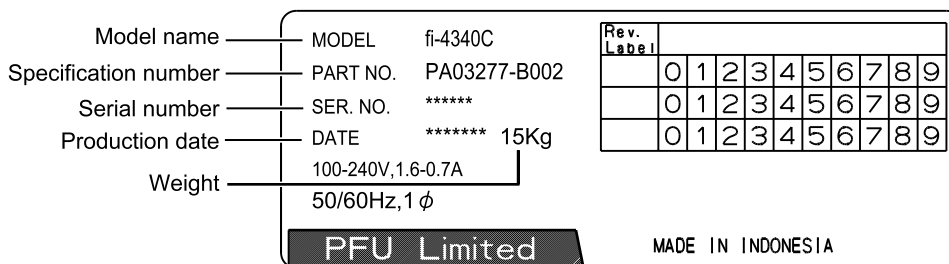

# Placing the scanner

This section describes how to place the scanner.

1. Place the Transport Lever.
2. Connect the SCSI cables.
3. Set the SCSI ID and the SCSI terminator.
4. Mount the Stacker.
5. Connect the power cable.

Turn the power switch off, before placing the scanner.

Turn the power switch off as follows:

## ■ Turning the power switch Off

1. Press the “O” side of the power switch to turn the power Off.

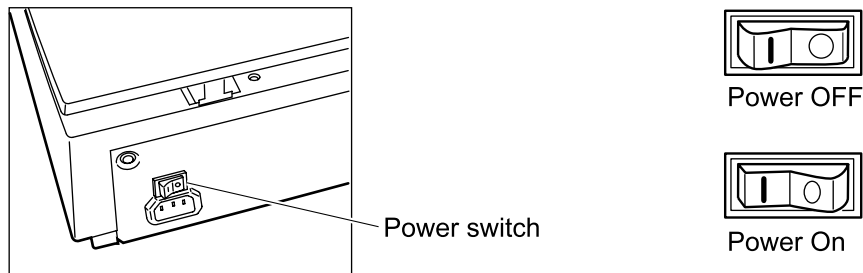

## ■ Placing the Transport Lever

To keep the scanner from being damaged during shipping, the carrier unit is fixed with a Transport lever. After placing the carrier unit where it will be installed, release the Transport lever as explained below.

1. Turn the Transport lever 90 degrees counterclockwise.

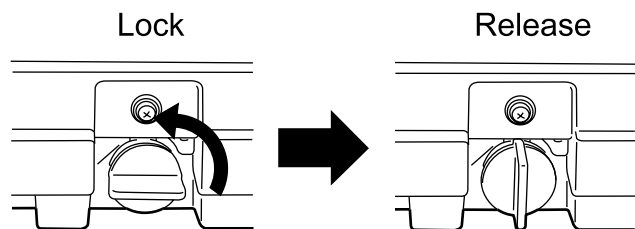

### CAUTION

Before moving the scanner, make sure that the Transport lever is locked to prevent possible damage. Before locking the Transport lever, make sure that the carrier has returned to the home position.

## ■ Connecting the interface cables

1. Connect the SCSI interface cables and secure them.

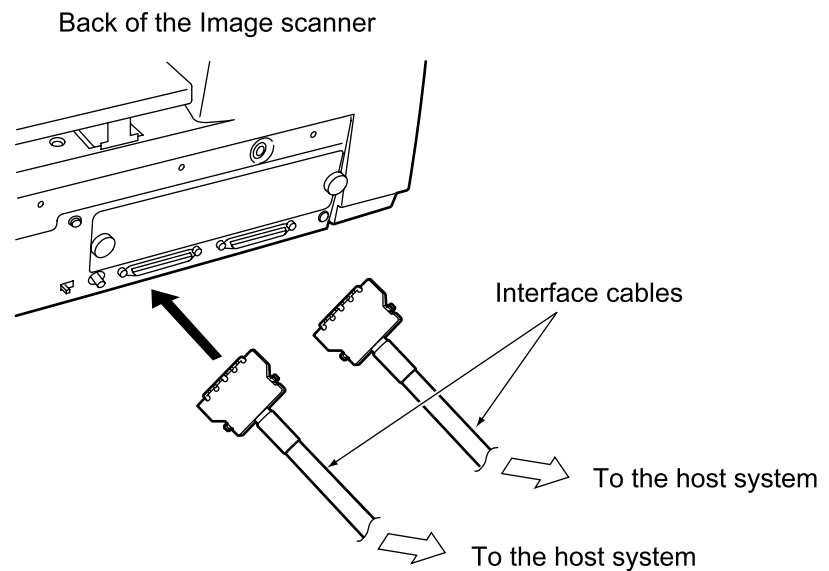

### NOTICE

1. Factory default for the SCSI terminator is On. If the scanner is in the middle of the daisy chain or of two devices, turn the scanner termination Off via the operator panel.
2. The factory default for the SCSI ID is 5. If the ID of the scanner is the same as the other device, change the ID via the operator panel or change the ID of the other device.

## ■ Setting the SCSI ID and the SCSI Terminator

The default of the SCSI ID is 5. The SCSI ID is set by using the Setup mode of the operator panel.

1. Turn the power Off by pressing the "0" side of the power switch.
2. Turn the SCSI-ID switch on the rear of the image scanner to set the SCSI-ID.

ID No.	Description
0 to 7	Can be set
8, 9	Return to default (Available ID NO. = 5) if set to 8 or 9.

3. Set the SCSI terminator switch on the rear of the image scanner to ON or OFF.



## NOTICE

The SCSI terminator switch is set to ON before shipment from the factory. When the image scanner is located in the middle of a SCSI daisy chain, change the terminator setting to OFF.

When the image scanner is located at the end the daisy chain, set the terminator to ON.

## ■ Mounting the Stacker

1. Press in the bottom of the pins on both sides of the stacker with your fingertips, and insert the stacker pins until they slot into the holes on the image scanner.

Stacker

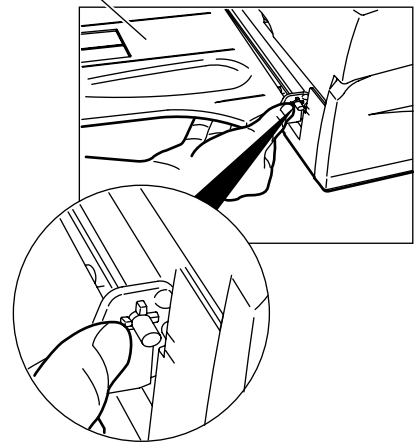

## ■ Connecting the power cable

1. Connect the power cable to the power inlet of the device and a power outlet.

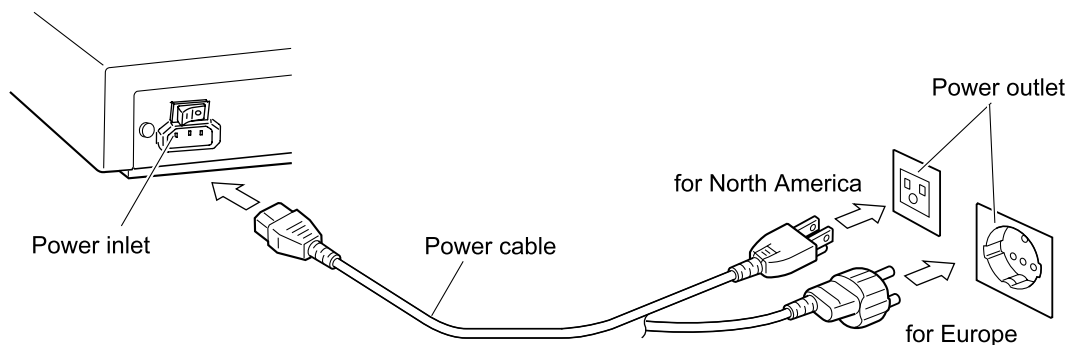



# ***HOW TO INSTALL THE DEVICE DRIVER***

---

*This chapter describes how to install this software.*

**Procedure.....3-2**

# Procedure

---

For details on how to install the device driver, refer to the attached installation guide and the device driver's user's guide in device driver's CD.

# OPERATING INSTRUCTIONS

---

*This chapter describes this scanner's operations.*

*Refer to the "Cleaning and Maintenance" manual for routine scanner maintenance.*

Turning the Power On .....	4-2
Waking up the Scanner from the Low Power Mode .....	4-3
Manual Feed Mode Setting .....	4-4
Loading Documents on the ADF .....	4-5
Loading Documents on the Document bed .....	4-9
Loading Documents Larger than the Document bed .....	4-10
Reading a Page from a Thick Book .....	4-11
Clearing Paper Jams .....	4-12

# Turning the Power On

This section describes how to turn the power On.

Press the “I” side of the power switch. The power turns On and the green Power lamp at the operator panel lights.

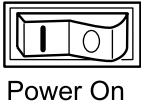
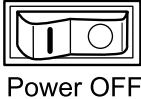
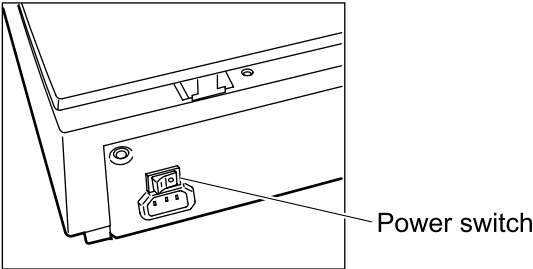

# Waking up the Scanner from the Low Power Mode

This section describes how to wake up the scanner from the Low Power Mode.

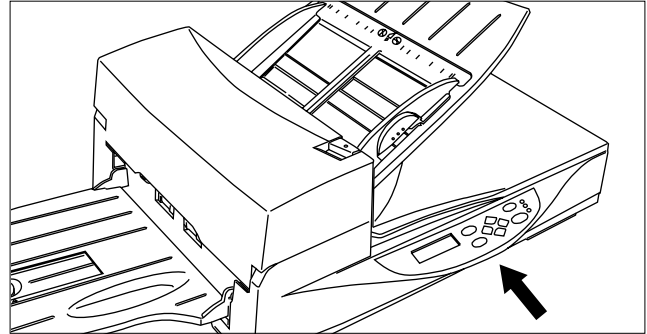

To wake up the Scanner, simply press a button, set the papers on the ADF, or send a command to scan from the host computer.

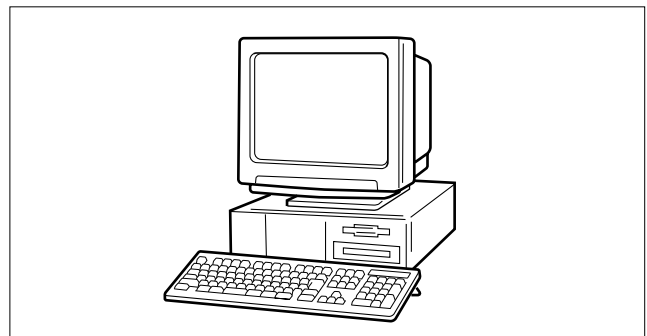
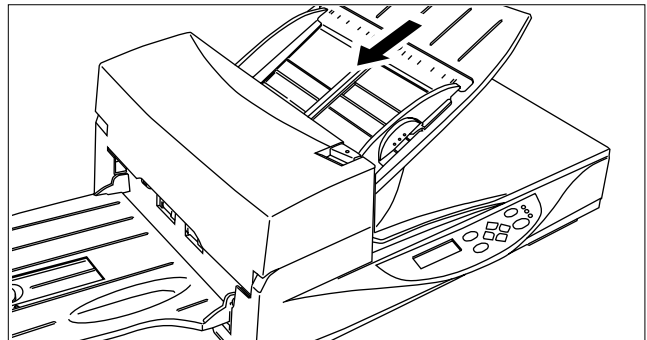

## NOTICE

As an ENERGYSTAR<sup>®</sup> partner, PFU Limited declares that this scanner meets the ENERGYSTAR<sup>®</sup> guidelines for energy efficiency.

# Manual Feed Mode Setting

In this mode, the scanner waits for some predetermined time before issuing a “Paper Empty” message after all documents are read. This predetermined time (time-out limit) is specified in the Setup mode. Therefore, you can set the next documents on the ADF paper chute without interrupting the reading operation.

The procedures for setting the manual feed mode are as follows:

1. Turn the power On and verify that “Scanner Ready” is displayed on the LCD.

Screen M1

```

                                     X X X X
R e a d y       X X X X X X 0 >

```

2. Press **Next** then the scanner displays Screen M2.

Screen M2

```

M o d e   S e l e c t   0
☐ R e a d i n g   M o d e

```

3. Press **Next** then the scanner displays Screen M3

Screen M3

```

M o d e   S e l e c t   1
M   M a n u a l   F e e d ?

```

4. Press **Enter** then the scanner displays Screen M4.

Screen M4

```

M 0 1   M a n u a l   F e e d
= N o / Y e s

```

5. Select “Yes” by pressing **◊**. Then press **Enter**.
6. Press **Exit** to return to the “Scanner Ready” screen. Note that “Manual Feed” is shown on the LCD. This means that the scanner is in Manual Feed mode.

Screen M1

```

M a n u a l       X X X X
R e a d y       X X X X X X 0 >

```



# Loading Documents on the ADF

## NOTICE

Be sure to change the position of the Transport Lever according to the Chapter2 "Placing the Transport Lever (page 2-3)" procedure before operation.

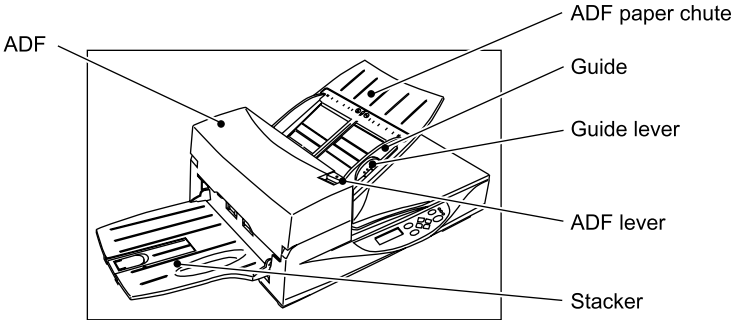

**1** Lift up the ADF paper chute and lock the bar in its operating position.

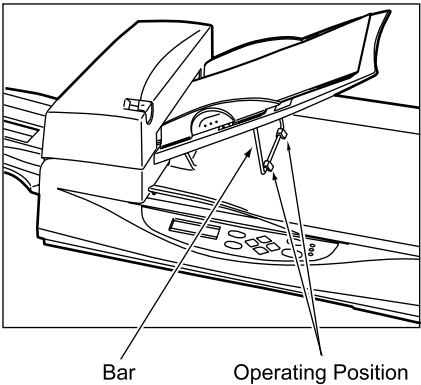

**2** Fan the sheets before setting a stack of documents on the ADF paper chute. For details see the next page.

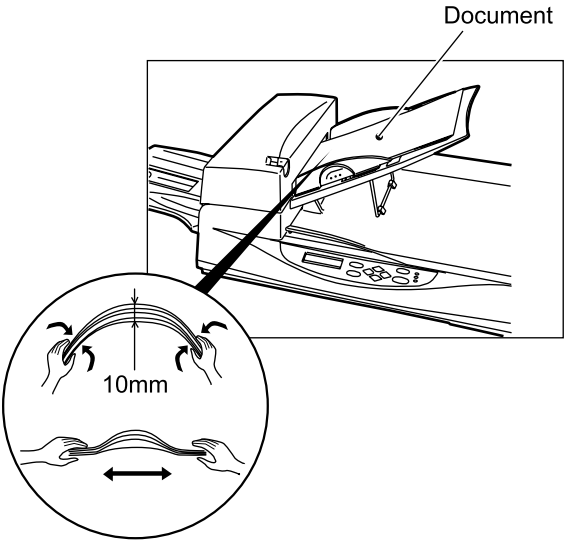

- Place the documents face down, with the top to the left as shown in A. (The long side is the top for landscape mode and the short side is the top for portrait mode.)
- Holding both ends with both hands, lift the documents.
- Hold the documents tightly with your left hand and bend them as shown in B.
- Grip the documents tightly with your right hand, loosen the grip of your left hand, and straighten as shown in C.
- Even up the feed edge of the batch of paper as shown in D.

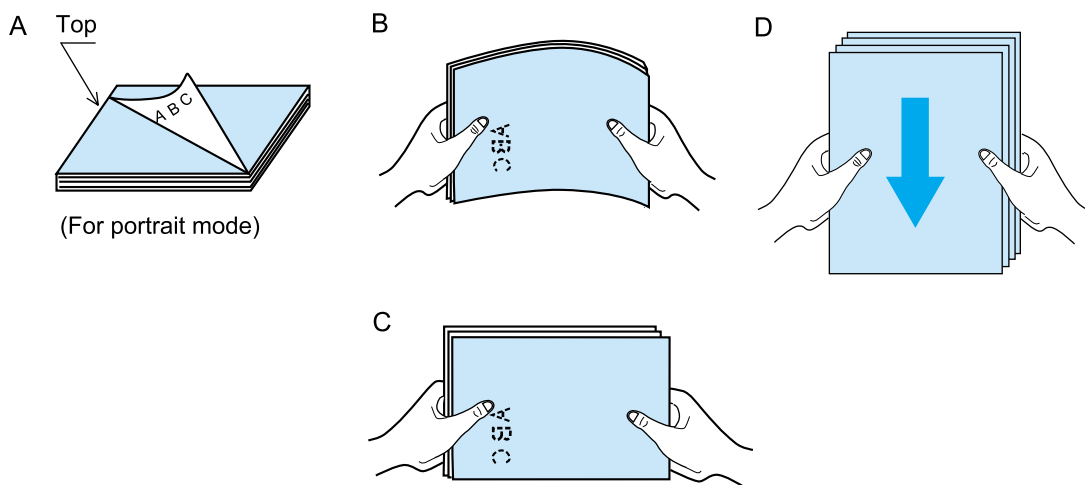

#### NOTICE

Reduce the batch size of the documents if double feed or mispick occurs.

#### NOTICE

Note the following when preparing the paper.

- Remove paper clips and staples. Flatten the staple holes.
- A preliminary document feed test may be necessary to avoid unexpected errors. If document slip or jam in the ADF (JAM error) or double feed occurs frequently, read the documents manually using the Document bed.

The following documents may be difficult to read properly using the ADF:

- Paper with clips or staples.
- Paper written on with wet ink.
- Paper of uneven thickness (for example, envelopes).
- Paper with large rumples or curls.
- Paper with folds or tears.
- Tracing paper.
- Coated paper.
- Carbon paper.
- Paper smaller than A8 (vertical)

- Paper larger than letter size in width (216 mm) or legal size in length (356 mm)
  - Materials other than paper (for example, clothes, metal foil, or OHP film).
  - Light-sensitive paper.
  - Paper which has perforations and drilling in an end.
  - Non-rectangular paper.
  - Very thin paper.
- Set documents on the ADF so that the curl of the leading edge does not exceed the measures shown below.

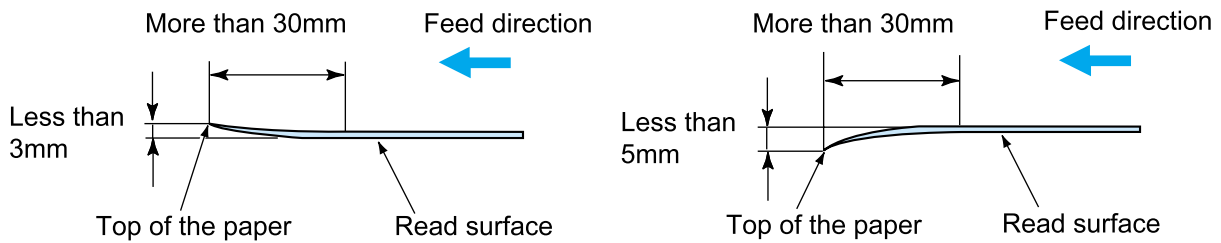

- To avoid skewing, do not feed documents of different widths during the same batch.

**3** Adjust the stacker extension to the paper size.

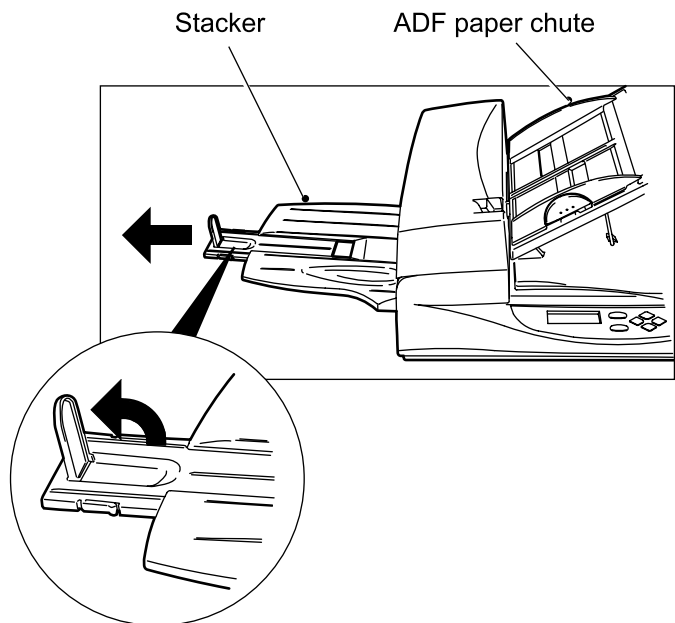

- 4** Set the guides so that there is a small clearance between the document edges and the guides. Load the document face down on the ADF paper chute and adjust the guides to the document width.

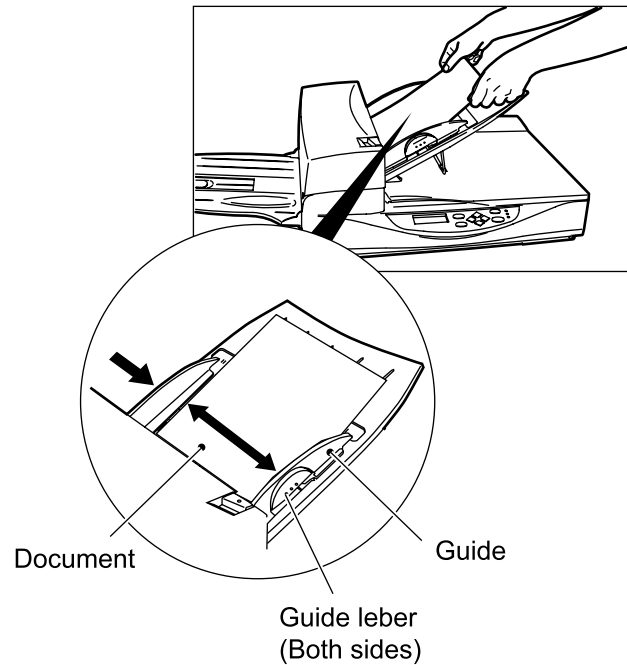

 **NOTICE**

- Squeeze the guide lever to free the guides.
- Do not load document stacks thicker than 8 mm.

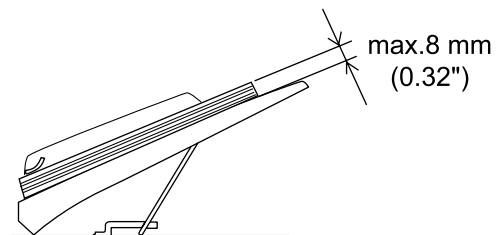

- Set the guides so that they touch the document sides.

- 5** After the read command is issued from the host system and the documents are read, scanned documents are expelled into the stacker for removal.

# Loading Documents on the Document bed

**⚠ CAUTION**

Do not look directly at the light source during the read operation.

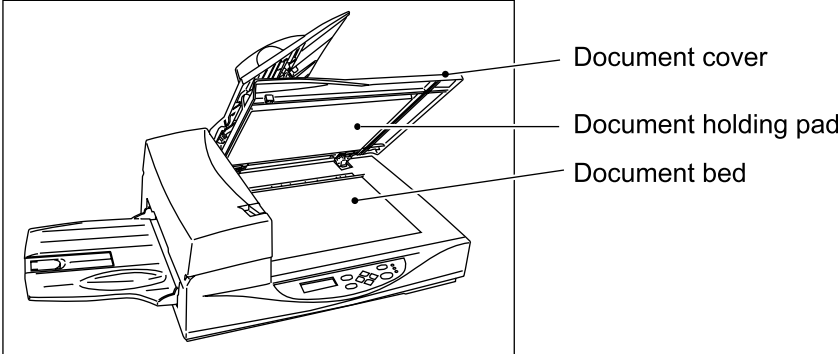

**1** Open the document cover.

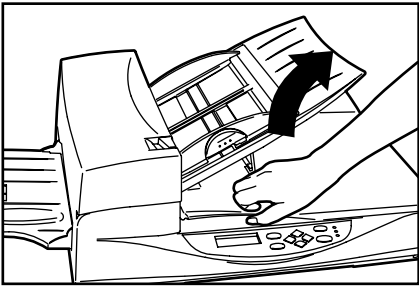

**2** Place the document face down and align the top left corner with the reference mark.

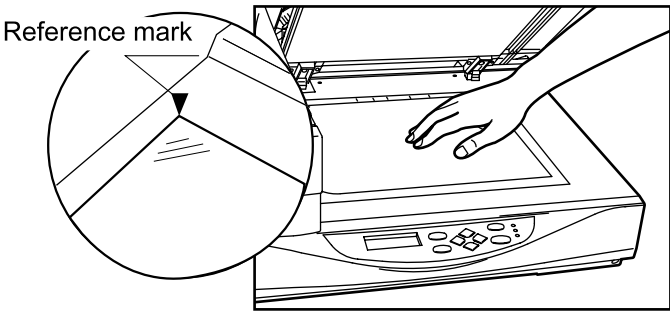

**3** Slowly close the Document cover.

**4** Issue the read command from the host system.

# Loading Documents Larger than the Document bed

## CAUTION

Do not look directly at the light source during the read operation.

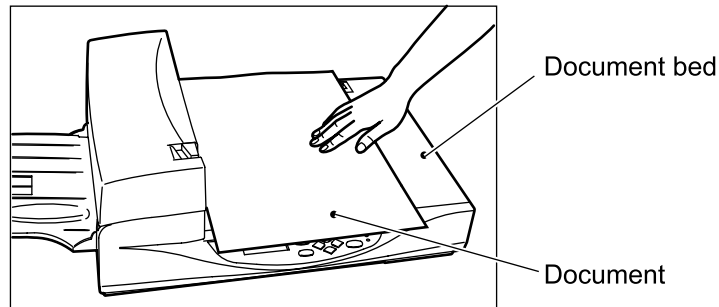

- 1** Open the Document cover to an angle of approximately 90 degrees, and lift up the cover (in the direction of the arrow) to remove it.

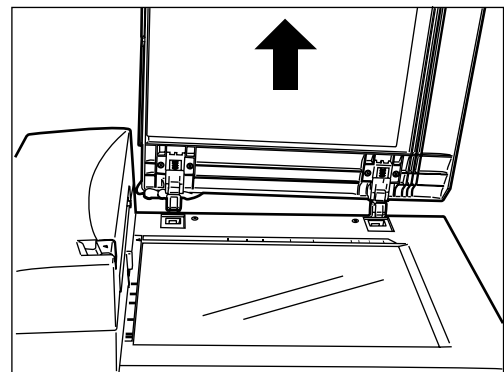

- 2** Place the document face down on the Document bed. Issue the read command from the host system.

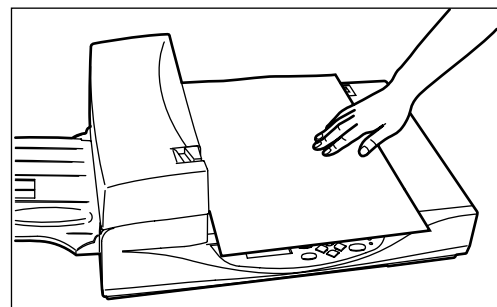

- 3** After the read operation, remove the document, re-attach the Document cover and close it gently.

# Reading a Page from a Thick Book

## CAUTION

Do not look directly at the light source during the read operation.

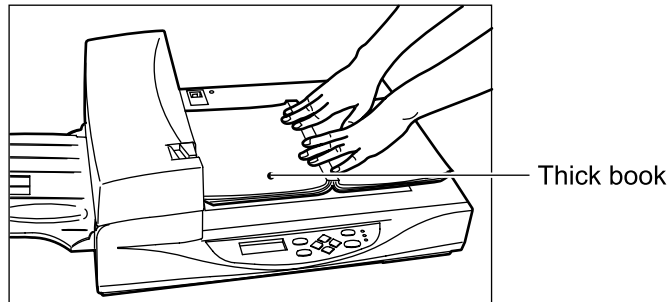

- 1** Open the Document cover.

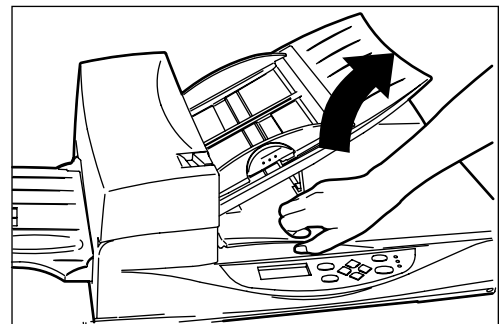

- 2** Place the book face down on the Document bed.

- 3** Issue the read command from the host system. Keep the cover open for the reading operation.

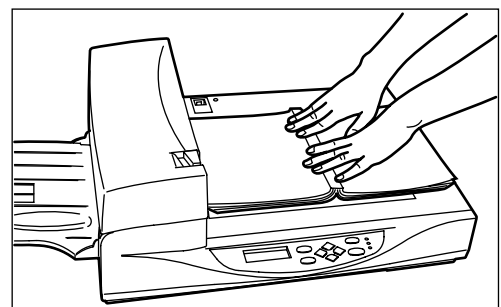

## NOTICE

Do not move the book during the read operation.

# Clearing Paper Jams

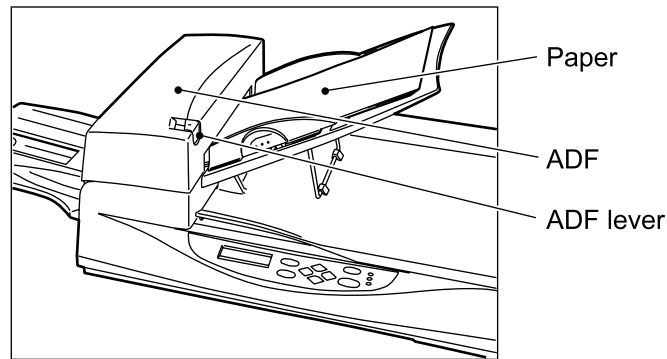

- 1** Remove all the documents from the ADF paper chute.

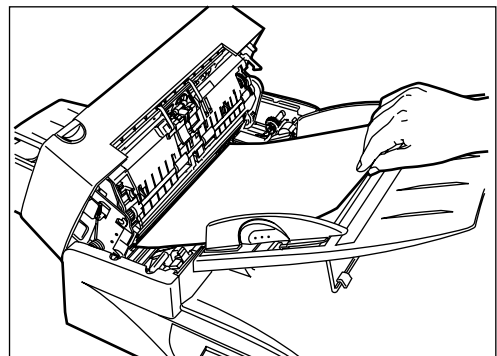

- 2** Pull the ADF lever to open the ADF.

- 3** Remove the jammed document(s).

## NOTES

- Inspect the paper and the paper path. Make sure no staples, paper clips or other materials caused the jam. All staples and paper clips should be removed from all documents before scanning.
- Be careful not to pull the spring for the Pick while removing a jammed document.

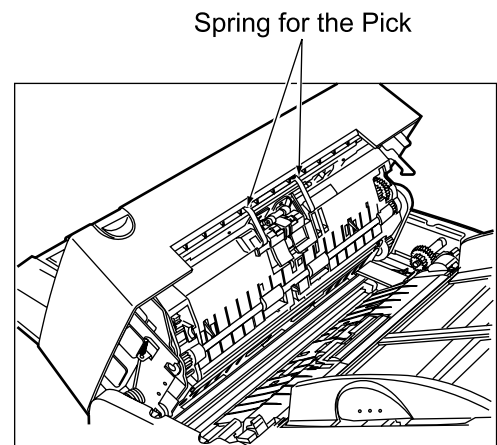

- 4** Close the ADF.



# ***ADF DOCUMENT SPECIFICATION***

---

*This chapter describes the document size and document quality required to use the ADF successfully.*

<b>Document Size.....</b>	<b>5-2</b>
<b>Document Quality.....</b>	<b>5-3</b>
<b>ADF Document Feeder Capacity.....</b>	<b>5-5</b>
<b>Areas not to be Perforated .....</b>	<b>5-6</b>
<b>Grounding Color Areas.....</b>	<b>5-7</b>
<b>Double Feed Detection Condition.....</b>	<b>5-8</b>
<b>Job Separation Sheet.....</b>	<b>5-9</b>

# Document Size

The following figure shows document sizes that the scanner can read using the ADF.

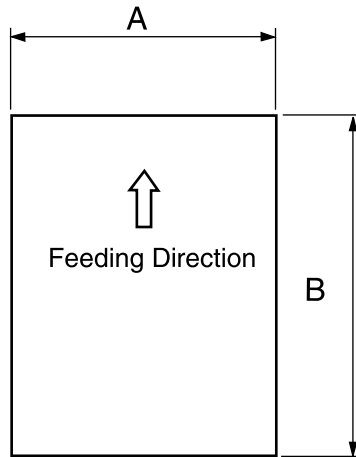

Scanner	Maximum		Minimum	
	A	B	A	B
fi-4340C	216 (8.5 in)	356 (14 in)	53 (2.1 in)	74 (2.9 in)

(Unit : mm)

# Document Quality

---

This section describes the types and weights of paper that the scanner can read and precautions in preparing documents to ensure maximal scanner functioning.

## ■ Document type

The recommended paper type for documents is as follows:

- Woodfree paper
- Plain paper (for example, the paper type specified for XEROX 4024)

When using any other type of paper, test feed a few sheets with the ADF to ensure the paper feeds properly before performing a large-scale reading operation.

Any paper can be used on the Document bed. However, the ground color specification must satisfy the specification described in the Grounding Color Area section.

## ■ Paper weight

The paper weight should fall within the following ranges:

- 52 to 127 g/m<sup>2</sup> (13.9 to 34 lb), 127g/m<sup>2</sup> (34lb) for A8

## ■ Precautions

A preliminary document feed test may be necessary to avoid unexpected errors. If document slip or jam in the ADF (JAM error) or double feed occurs frequently, read the documents manually using the Document bed.

The following documents may be difficult to read properly using the ADF:

- Paper with clips or staples.
- Paper written on with wet ink.
- Paper of uneven thickness (for example, envelopes).
- Paper with large rumples or curls.
- Paper with folds or tears.
- Tracing paper.
- Coated paper.
- Carbon paper.
- Paper smaller than A8 (vertical)

- Paper larger than letter size in width (216 mm) or legal size in length (356 mm)
- Materials other than paper (for example, clothes, metal foil, or OHP film).
- Light-sensitive paper.
- Paper which has perforations and drilling in an end.
- Non-rectangular paper.
- Very thin paper.

### NOTICE

- When scanning a translucent document, set the density to light mode.
- Carbonless papers have a chemical composition that damages the Pad and the rollers which send a paper (Pick roller etc). Therefore, note the following:
  - Cleaning : If mispicks occur frequently, clean the Pad and Pick roller in accordance with the “Cleaning and Maintenance” manual.
  - Replacement of parts :The life of the Pad and Pick roller may be shorter than if PPC paper documents are fed.
- The leading edge of all documents fed using the ADF should be straightened so the curl of the paper meets the specifications shown below:

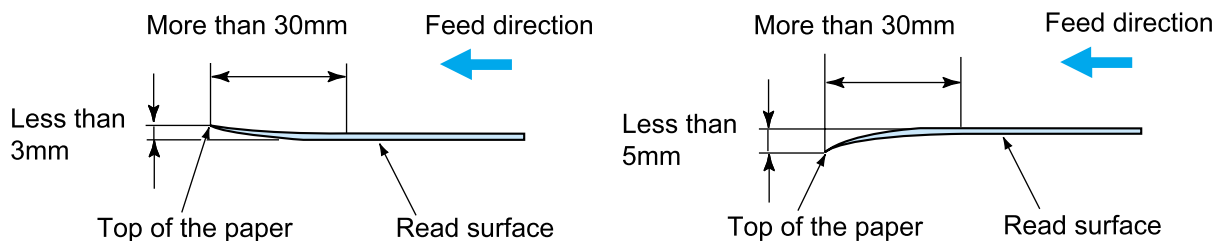

- To prevent roller smudging, avoid scanning a document filled out in a pencil.  
Clean the roller as often as possible when scanning many documents.

# ADF Document Feeder Capacity

The number of pages that can be loaded into the ADF chute depends on the paper size and the ream weight. This information is shown in the following graph:

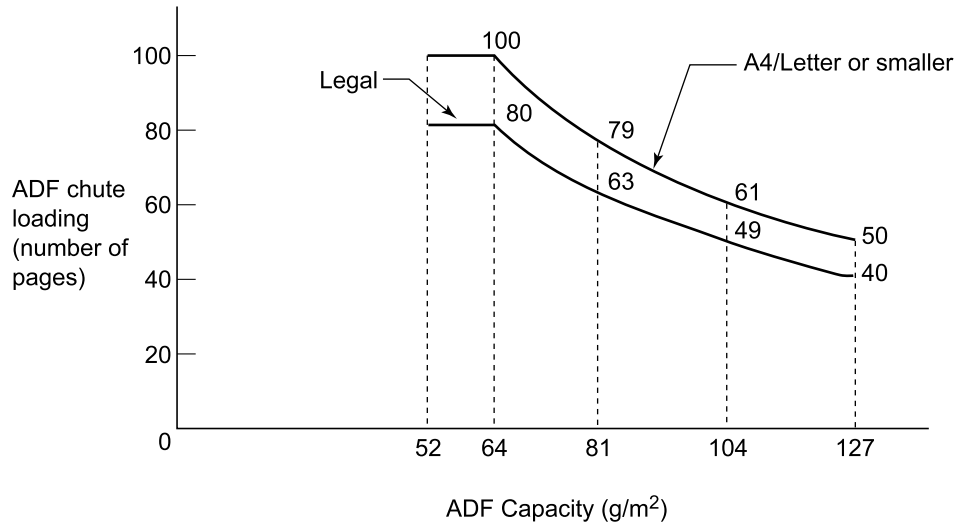

Paper weight conversion table

Country	Unit	Conversion						
		45	55	64.6	77.5	90	109.8	135
Japan	kg/ream	45	55	64.6	77.5	90	109.8	135
US	lb	13.9	17	20	24	27.9	34	41.8
Europe	g/m <sup>2</sup>	52	64	75	90	104	127	157

# Areas not to be Perforated

With the ADF, perforations in the shaded areas may cause errors. If you must read data from such a paper, use the Document bed:

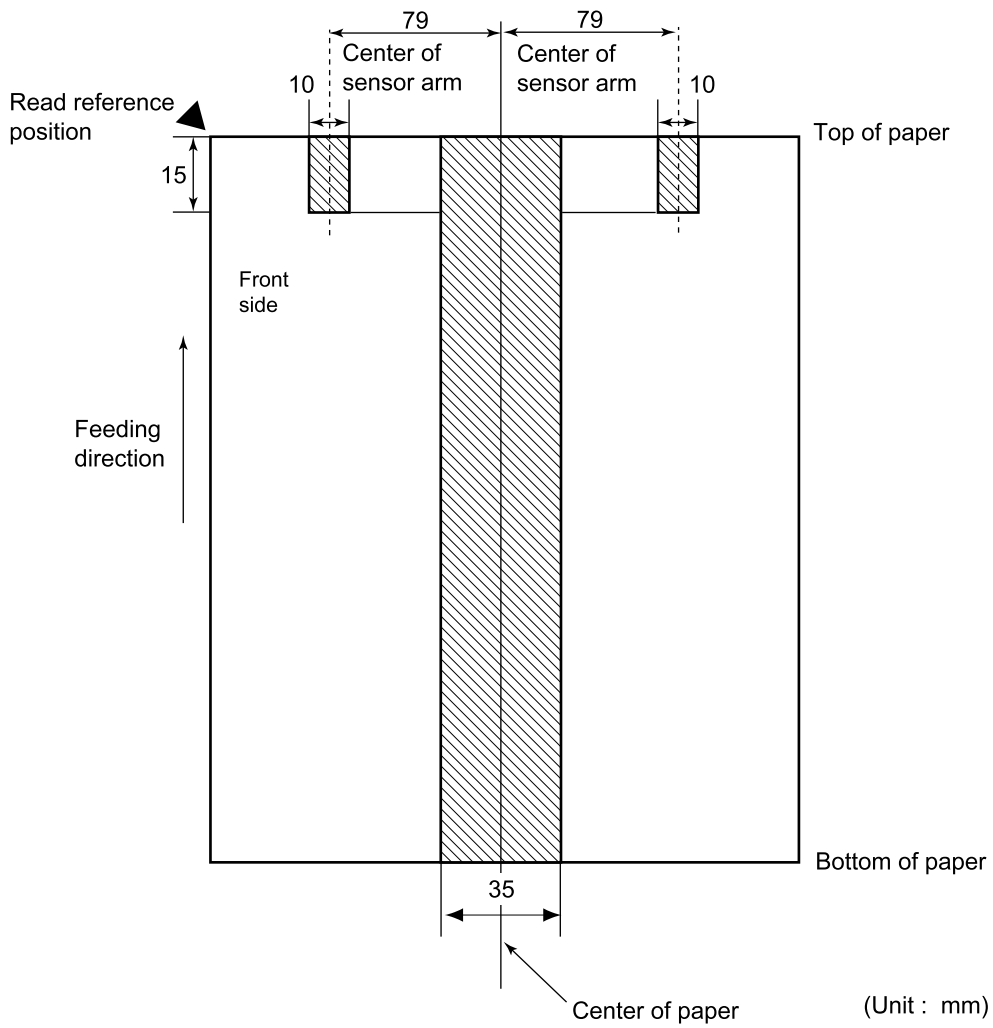

# Grounding Color Areas

The shaded area in the Figure below should have paper grounding color (white) or drop-out color. If not, turn the white level following Off when reading.

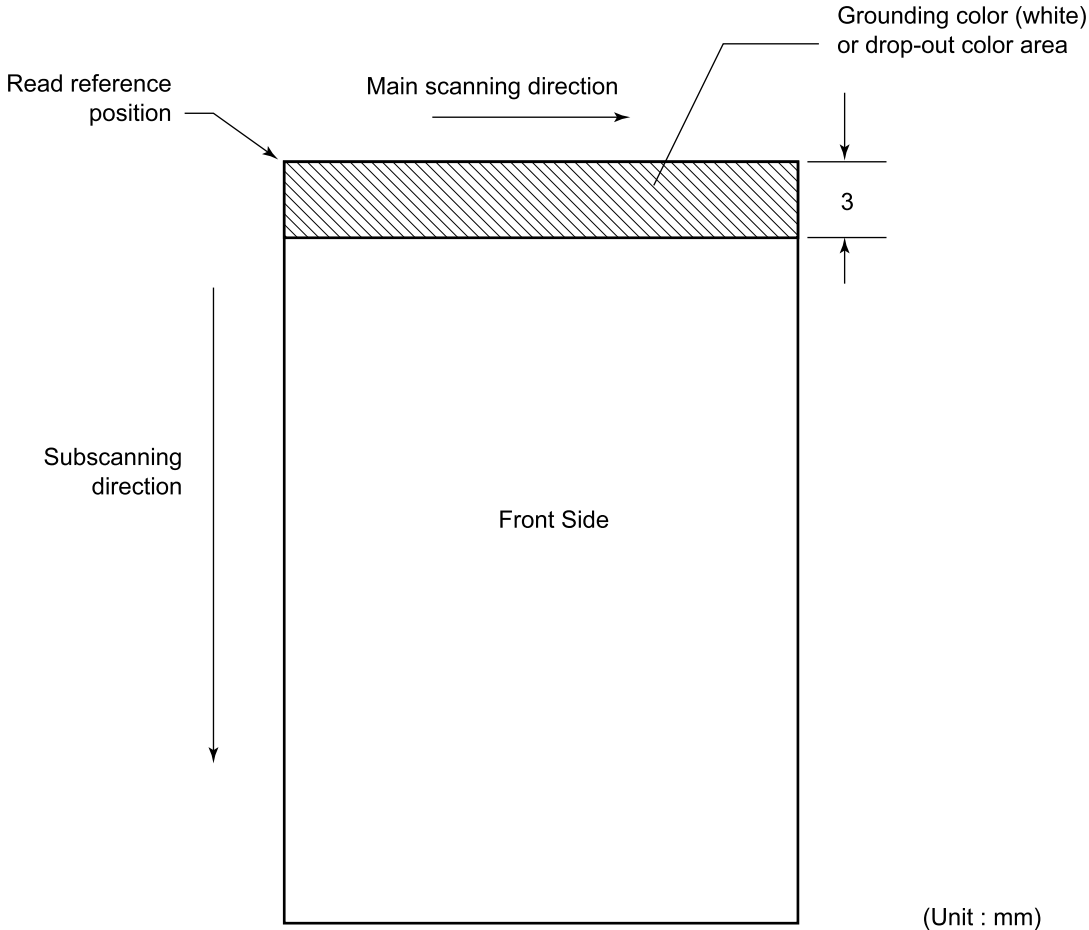

# Double Feed Detection Condition

When the double-feed sensor is used, the thickness or the combination of the thickness and the length of the document is subject to the following specifications:

- 1 Thickness: 0.065 mm to 0.15 mm
- 2 Paper length accuracy: 1% or less
- 3 Any black print at the center of the leading edge of the paper is not allowed. (10 mm x 10 mm)
- 4 No binding holes are allowed within 35 mm of the middle (halfway point) along the center of the paper.
- 5 Printing duty: 12 % or less
- 6 The deviation of the amount of transparent light on the base color area should be less than 10 %.

## NOTICE

Certain paper types or a certain condition of paper result in lower detection rates in terms of double feed detection.

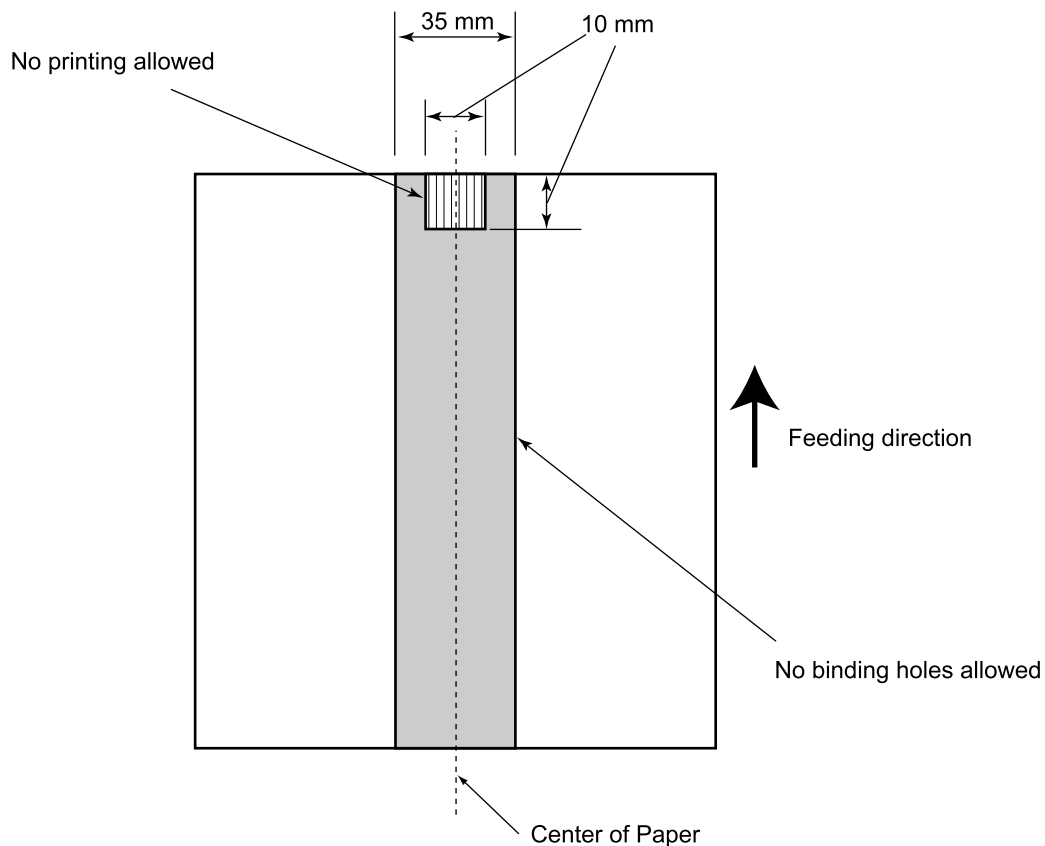



# Job Separation Sheet

## 1 Shape

The following shows the typical format of the job separation sheet.

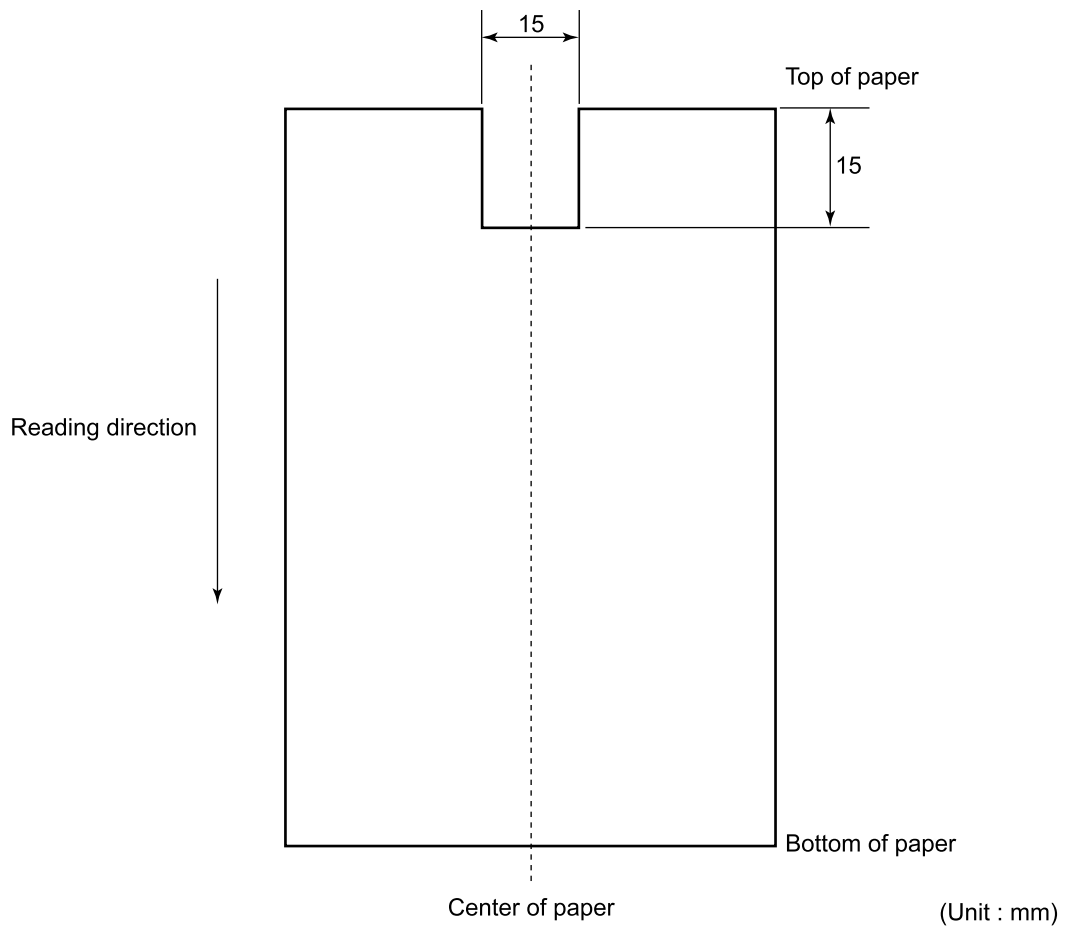

## 2 Paper conditions

The paper conditions are the same as the specification described before. But the paper width must be A4 or larger (210 mm or larger in width).



# ***OPERATOR PANEL MESSAGE***

---

*This chapter describes the components of the scanner, part names, and LED indicators. After unpacking the scanner, confirm that all components have been received by checking them against the list in the first section.*

Counter Display .....	6-2
Operation status .....	6-3
Temporary error.....	6-4
Alarm .....	6-5

# Counter Display

The displays for the Paper and Abrasion counters are shown below:

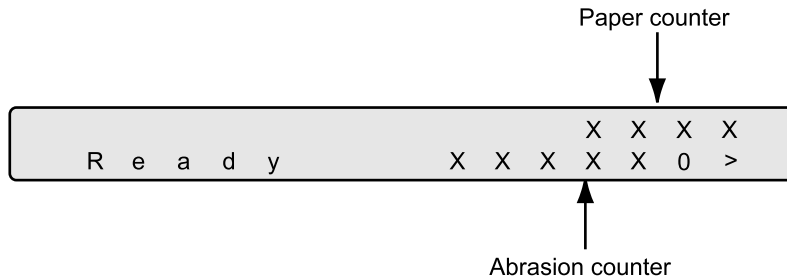

Simultaneously press the and arrow buttons for at least 1 second, to switch to the Life counter panel display as shown below:

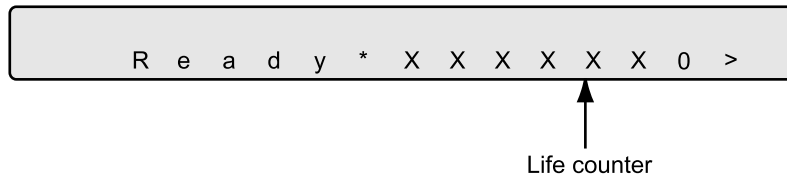

Counter	Function	
Paper counter	When the  button is pressed for at least 1 second	The paper counter counts the number of scanned sheets from the start of reading until Paper Empty or an error is detected. The counter is automatically reset at the start of reading. The counter is used for checking the number of the sheets scanned in one batch.
	When the  button is pressed for at least 1 second	This counter increments each time a document is scanned. It is not initialized until the power is turned off. The counter can be used, for example, for checking the number of sheets that have been scanned in one day.
Abrasion counter	The abrasion counter counts the accumulated number of scanned sheets. This counter increments every 10 sheets. It is useful to check the cleaning cycle or the parts replacement cycle. How to reset it is described in Chapter7 "SETUP MODE".	
Life Counter	Keeps a cumulative count of the number of scans made after shipping. This counter increments by 1 after every 10 scans and may be used to estimate of the device's remaining scan life.	

## NOTICE

When the counter value is 0, no number is displayed.

# Operation status

The operation status messages are as follows:

<Power-on>

W a r m i n g - u p   N o w ! !

<Reading>

N o w   R e a d i n g !

<Low Power Mode>

When the Scanner Display turns Off and the power  indicator remains "On", the scanner is in the Low Power Mode.

## NOTICE

One of the following will wake up the scanner:

- Pressing any button.
- Setting the paper on the ADF.

Sending a command from the host computer.

<Waiting for Start>

(Only When the Video Interface Option is installed.)

The scanner displays the following screen when waiting for the Start button to be pressed:

S t a r t   S W   O N !

<Cleaning request>

When the ADF glass cleaning is necessary, the scanner displays the following on the LCD:

C l e a n   A D F   G l a s s  
N o w   R e a d i n g !

When the Pick roller cleaning is necessary, the scanner displays the following on the upper line:

C l e a n   P i c k r o l l e r  
N o w   R e a d i n g !

Clean the Pick roller or the ADF glass in accordance with the manual, "Cleaning and Maintenance".

# Temporary error

---

<Hopper empty>

P a p e r   E m p t y

This message is displayed if there is no more paper on the ADF paper chute during a read operation in ADF mode. Fill the ADF paper chute with paper. To enable the read operation, press the stop button.

---

<Jam>

P a p e r   J a m

This message is displayed if a document is jammed in the ADF. See the "Cleaning and Maintenance" manual for removing jammed documents.

---

<ADF cover open>

A D F - C o v e r   O p e n

This message is displayed if the ADF is not closed completely. Close the ADF completely. To enable the read operation, close the ADF completely.

---

<Double feed error>

D o u b l e   F e e d

This message is displayed when the ADF detects the Double feed error. Check the document and re-scan the document.

# Alarm

One of the following messages is displayed if an error occurs in the scanner. If one of the following error messages is displayed, turn the power Off and then On again. If the same message is displayed, contact your service representative.

<Optical alarm front>

F r o n t   S i d e  
O p t i c a l   A l a r m

<Optical alarm back>

B a c k   S i d e  
O p t i c a l   A l a r m

<FB mechanism alarm>

F l a t b e d  
M e c h a n i c a l   A l a r m

## NOTICE

When the total number of sheets scanned by the ADF is less than 100, the message above and the message below are displayed alternately. Remove the bracket (Shipping Lock) that holds the carrier in place.

C h e c k   S h i p p i n g  
L o c k

<Motor fuse alarm>

M o t o r f u s e   A l a r m

<Lamp fuse alarm>

L a m p f u s e   A l a r m

<Image transfer alarm>

I m g   T r a n s   A l a r m

<Memory alarm>

M e m o r y   A l a r m

<EEPROM alarm>

E E P R O M   A l a r m

<FAN alarm>

F A N   A l a r m

---

<IPC Board alarm>  
(Image Processing board)

I P C   B o a r d   A l a r m

---

<Self-diagnostics Error>

The Power indicator (LED) and Check lamp blink alternately.



# ***SETUP MODE***

---

*This chapter describes the setup mode of the scanner.*

<b>Activating the Setup Mode .....</b>	<b>7-2</b>
<b>Contents of the Setup Mode.....</b>	<b>7-3</b>

# Activating the Setup Mode

This section describes how to activate the setup mode.

1. Turn the power On. Then the scanner displays “Scanner Ready” on the LCD.

Screen M1

```

                                     X X X X
R e a d y       X X X X X 0 >

```

2. If the scanner does not have a video interface option, go to the procedure step 3.

Press **Next** then the scanner with the video interface option displays Screen M2.

Screen M2

```

M o d e   S e l e c t   0
☐ R e a d i n g   M o d e

```

3. Press **Next** then the scanner displays Screen M3.

Screen M3

```

M o d e   S e l e c t   1
M   M a n u a l   F e e d ?

```

4. Press **Next** then the scanner displays Screen M4.

Screen M4

```

M 0 1   M a n u a l   F e e d
= N o / Y e s

```

5. Press **Enter**. Now the scanner is at Screen 1 (page 7-5) in Setup mode.

## NOTICE

Any time you press **Exit**, you can return to the “Scanner Ready” screen.

## Contents of the Setup Mode

This section describes the contents of the setup mode.

No	Item	Description	Selectable parameters	Default
1	Double feed check	Specifies the double feed detection. Double feed is detected by checking the document length and/or paper thickness.(*1)	No/Yes	No
2	Length check =No/10/15/20 mm	Specifies the document length to enable double feed detection sets the document length.	Tolerance: No/10/15/20mm	No
3	IPC pre-setting	Scanner automatically sets the recommended reading parameters. 3 sets of parameters are available when IPC-4D is not installed.	Document: No 1: Sharpen 2: Darken Character 3: Copy Quality	No
4	Resetting of abrasion counter	Resets the abrasion counter.	---	---
5	Pick start time setting	Specifies the time from document Insertion to the start of picking. User can select the most comfortable Pick start time for the job.	Time: 0.2 to 29.8 sec	1.0 sec
6	Time-out limit setting	Specifies the time the scanner waits for the next document insertion after the last document was scanned.	Time: 27 values from 1 to 1999 sec	30 sec
7	ADF front offset setting(*2)	Specifies the horizontal and vertical offset of the front side image when using the ADF.	Offset: H:-2 to +3 mm V:-2 to +3 mm	Offset: H: 0 mm V: 0 mm
8	ADF back offset setting(*2)	Specifies the horizontal and vertical offset of the back side image when using the ADF.	Offset: H:-2 to +3 mm V:-2 to +3 mm	Offset: H: 0 mm V: 0 mm
9	Document bed offset setting(*2)	Horizontal and vertical offset of the FB image is specified.	Offset: H:-2 to +3 mm V:-2 to +3 mm	Offset: H: 0 mm V: 0 mm
10	IPC status display	Displays whether or not the image processing board (IPC-4D) and the Imprinter option are installed.	---	---
11	Low Power Mode setting	Changes the default setting of the duration for power save.	5 min. to 60 min.	15 min.
12	Select Interface	Selects the interface when the scanner has a board in the third party Slot.	Auto/SCSI/Tps	Auto
13	Display TPS Board ID Number	Displays the ID number of the board which is installed in the third party Slot.	---	---

(Continued)

No	Item	Description	Selectable parameters	Default
14	IPC mode	When the IPC-4D image processing board is installed in the third party Slot, select this IPC-4D board or the image processing circuit built in the scanner.	Standard/IPC4D	Standard
15	ADF Edge Erasing	Adjusts the edge areas to be erased from the image scanned by the automatic document feeder (ADF).	Left/Right: 0 to 15 mm Top: 0 to 15 mm Bottom: -7 to +7 mm	Left/Right: 0 mm Top: 0 mm Bottom: 0 mm
16	FB Edge Erasing	Adjusts the edge areas to be erased from the image scanned by the flat bed (FB).	Left/Right: 0 to 15 mm Top: 0 to 15 mm Bottom: 0 to 15 mm	Left/Right: 0 mm Top: 0 mm Bottom: 0 mm
17	Select read color	Selects the color to be read in unicolor reading.	R/G/B/W	G
18	Gray mode	Switches between quality priority scanning and speed priority scanning with respect to the default setting when scanning grayscale images.	Normal/ Draft/ Quality	Normal
19	Remaining ink	Displays the remaining amount of ink when the Imprinter option is attached and resets the remaining ink counter when replacing the ink.	Reset/No	No
20	Print No.	Selects printing of Nos. when the Imprinter option is attached.	on/off	off

\*1) Some restrictions apply to the detection of a double feed.

\*2) This offset refers to the difference from the value adjusted by automatic offset adjustment.

## 1 Setting double feed detection (Paper Thickness)



When you set the use of double feed detection, you must set it as follows:

1. Press **Next** or **Previous** and let the scanner display Screen 1.



Screen 1

!	0	1		D	o	u	b	l	e		F	e	e	d	
=	N	o	/	Y	e	s	→	1	/	2	:	S	t	o	p

2. At Screen 1.

Press either the  or  button to set the double feed detection according to the paper thickness (transmitted light).

The paper thickness is checked using the difference between two consecutive sheets of paper fed from the ADF. On this screen, select whether or not to check for double feeding, and select the error processing.

Each time either of these buttons is pressed, the location of the blinking moves. When the  button is pressed, the blinking moves from (1) to (3). When the  button is pressed, the blinking moves in the opposite direction. However, if the setting by the host computer is valid, the location of the blinking does not move when either button is pressed.

- (1) “**No**” is blinking: Paper thickness is not checked.
- (2) “**Yes**” and “**1**” are blinking: Paper thickness is checked. However, a detected double feed error is displayed on the screen only; processing is continued.
- (3) “**Yes**” and “**2: Stop**” are blinking: Paper thickness is checked. When the double feed error is detected, the scan processing is stopped. The error is then reported to the host.

If you want to disable the double feed, select “No” then press **Enter**. Press **Exit** to return.

### NOTICES

1. Double Feed detection might have better results when both the paper thickness and the paper length are used.
2. When the document in ADF is not the double fed document, the previous document might be double fed, in case the scanner stops feeding by using the double feed detection.
3. Depending on the type of printing on the document, a double feed may not be detected by the paper thickness.

## 2 Setting double feed detection (Paper Length)

1. Press **Next** or **Previous** and let the scanner display Screen 2.

Screen 2

```
! 0 2   L e n g t h   C h e c k
= N o / Y e s → 1 / 2 : S t o p
```

2. Press either the **◁** or **▷** button to set double feed detection according to paper length. The paper length is checked using the difference between two consecutive sheets of paper fed from the ADF.

Each time either of these buttons is pressed, the location of the blinking moves. When the **▷** button is pressed, the blinking moves from (1) to (3). When the **◁** button is pressed, the blinking moves in the opposite direction. However, if the setting by the host computer is valid, the location of the blinking does not move when either button is pressed.

- (1) **“No”** is blinking: Paper length is not checked.
- (2) **“Yes”** and **“1”** are blinking: Paper length is checked. However, a detected double feed error is displayed only on the screen; processing is continued.
- (3) **“Yes”** and **“2: Stop”** are blinking: Paper length is checked. When the double feed error is detected, the scan processing is stopped. The error is then reported to the host.

If you want to disable the double feed, select “No” then press **Enter**. Press **Exit** to return.

After pressing **Enter**, the scanner displays the Screen 3.



Screen 3

```
! 0 2 - 1   L e n g t h
= 1 0 / 1 5 / 2 0   m m
```

3. Press either the **◁** or **▷** button to set double feed detection (paper length). When the **▷** button is pressed, the blinking moves from (1) to (3). When the **◁** button is pressed, the blinking moves in the opposite direction.
  - (1) The **“10”** is blinking: Threshold is 10mm
  - (2) The **“15”** is blinking: Threshold is 15mm
  - (3) The **“20”** is blinking: Threshold is 20mm



### 3 Setting IPC pre-set mode

When you set the use of the IPC pre-set mode, you must set it as follows:

1. Press “Next”  or “Previous”  and let the scanner display Screen 4.

Screen 4

```
! 0 3   I P C   P r e - S e t
= N o
```

2. At Screen 43, press  or  to select the pre-Setting and press  to activate the pre-setting. Then the scanner displays Screen 5.

Screen 5

```
! 0 3 - 1   U s e   I P C
      P r e s e t ?   Y e s / N o
```

#### NOTICES

The following IPC pre-settings can be selected when IPC-4D is installed:

Preset 1: Captures texts printed on the colored background

Preset 2: Produces an image with good contrast

Preset 3: OCR Smoothing

Preset 4: Image Smoothing

Preset 5: Dither

Preset 9:Pre-printed paper (color) orientation

Preset 10:No-carbon paper orientation

The following built-in IPC pre-settings can be selected even though IPC-4D is not installed:

- Sharpen

- Darken Character

- Copy Quality

3. At Screen 5, select “Yes” or “No”. Note that when you select “Yes”, the IPC setting from the Host computer is ignored. If you select “No”, the IPC setting will be changed according to the host setting.



Finally press .

#### NOTICE

When you select the Copy Quality, select the scanner and printer settings carefully to get the best quality.

## 4 Reset of the abrasion counter



When you reset the abrasion counter, you must set it as follows:



1. Press “Next”  or “Previous”  and let the scanner display Screen 6.

Screen 6



!	0	4		A	b	r	a	t	i	o	n		C	N	T
=	X	X	X	X	X	X		R	e	s	e	t	/	N	o

2. At Screen 6;

If you want to reset the abrasion counter, select “Yes” through  or  button and press . Go to procedure 3.

If you do not want to reset the abrasion counter, select “No” and press . Finally press  to return.

3. At Screen 7;



If you want to reset the abrasion counter, select “Yes” and press . If you do not want to reset it, select “No” and press . Press  to return.

Screen 7

!	0	4	-	1		R	e	s	e	t	/	N	o	W
						N	o	/	Y	e	s			





## 5 Setting the pick start time

When you set the pick start time, you must set it as follows:

1. Press “Next”  or “Previous”  and let the scanner display Screen 8.



Screen 8

!	0	5		P	i	c	k		s	t	a	r	t
=	1	.	0		S	e	c						

2. At Screen 8, press  to increase the Pick start time or press  to decrease the Pick start time. Then press  to activate the setting. Finally press  to return.





## 6 Setting the time-out limit

1. Press “Next”  or “Previous”  and let the scanner display Screen 9.

Screen 9

```
! 0 6   T i m e - o u t
= 3 0   S e c
```

2. At Screen 9, press  to increase the number or press  to decrease the time-out limit. Then press  to activate the setting.

### NOTICE



Default is 30 seconds.

3. Press  to return.

## 7 ADF Front Offset Setting

## 8 ADF Back Offset Setting

## 9 Document bed Offset Setting

1. Press “Next”  or “Previous”  and let the scanner display the following:

- For an ADF front offset setting

Screen 10

```
! 0 7   A D F   F . O f f s e t
      C h a n g e ?   N o / Y e s
```

- For an ADF back offset setting

Screen 11

```
! 0 8   A D F   B . O f f s e t
      C h a n g e ?   N o / Y e s
```

- For a Document bed offset setting

Screen 12

```
! 0 9   F B   O f f s e t
      C h a n g e ?   N o / Y e s
```

2. At Screen 10, Screen 11, or Screen 12, select “Yes” by pressing the  $\diamond$  or  $\diamond$  button, then press **Enter**. The scanner displays Screen 13. (X = 7, 8, or 9)

Screen 13

```
! 0 X - 1 R e t u r n   t o
d e f a u l t ?   N o / Y e s
```

3. At Screen 13, if you want to let the offset return to default, select “Yes” otherwise “No” then press **Enter**. The scanner displays Screen 14, Screen 15 or Screen 16.

- For an ADF front offset setting

Screen 14

```
! 0 7 - 2   F r o n t   H
H = + 0 . 0 m m ( + : L e f t )
```

- For an ADF back offset setting

Screen 15

```
! 0 8 - 2   B a c k   H
H = + 0 . 0 m m ( + : L e f t )
```

- For a Document bed offset setting

Screen 16

```
! 0 9 - 2   F B   H
H = + 0 . 0 m m ( + : L e f t )
```

4. At Screen 14, Screen 15 or Screen 16, press  $\diamond$  to increase the offset or press  $\diamond$  to decrease offset. The increment or decrement is 0.5 mm.

Then press **Enter** to activate the setting. The scanner displays Screen 17, Screen 18 or Screen 19.

- For an ADF front offset setting

Screen 17

```
! 0 7 - 3   F r o n t   V
V = + 0 . 0 m m ( + : U p )
```

- For an ADF back offset setting

Screen 18

```
! 0 8 - 3   B a c k   V
V = + 0 . 0 m m ( + : U p )
```

- For a Document bed offset setting

Screen 19

```
! 0 9 - 3   F B   V
V = + 0 . 0 m m ( + : U p )
```

- At Screen 17, Screen 18 or Screen 19, press  $\diamond$  to increase the offset or press  $\diamond$  to decrease the offset. Then press **Enter** to activate the setting. The scanner displays the next item of the setup mode.

## 10 IPC Status Display

This function allows you to check whether or not the IPC-4D (IMAGE PROCESSING CIRCUIT BOARD) is installed, and whether or not fi-CMP3 (JPEG COMPRESSION BOARD) is installed, and whether or not fi-434PR (IMPRINTER) is installed.

Check whether or not the respectively option is installed as follows.

- Press "Next"  $\diamond$  or "Previous"  $\diamond$ .

if an IPC4D (IMAGE PROCESSING CIRCUIT BOARD) is installed, Screen 20 will appear.

Screen 20

!	1	0		I	P	C	
				I	P	C	- 4 D

if an IPC4D (IMAGE PROCESSING CIRCUIT BOARD) is not installed, Screen 21 will appear.

Screen 21

!	1	0		I	P	C	
				N	O		

if a fi-434PR (IMPRINTER) only is installed, Screen 22 will appear.

Screen 22

!	1	0		I	P	C		P	R	T
				N	O			O	K	

if fi-434PR (IMPRINTER) and IPC4D (IMAGE PROCESSING CIRCUIT BOARD) are installed, Screen 23 will appear.

Screen 23

!	1	0		I	P	C		P	R	T
				I	P	C	- 4 D	O	K	

if a fi-CMP3 (JPEG COMPRESSION BOARD) only is installed, Screen 24 will appear.

Screen 24

!	1	0		I	P	C		J	P	E	G
				N	O			O	K		

if IPC4D (IMAGE PROCESSING CIRCUIT BOARD) and fi-CMP3 (JPEG COMPRESSION BOARD) are installed, Screen 25 will appear.

Screen 25

!	1	0		I	P	C		J	P	E	G
				I	P	C	- 4 D	O	K		

if fi-434PR(IMPRINTER) and fi-CMP3(JPEG COMPRESSION BOARD) are installed,Screen 26 will appear.

Screen 26

!	1	0	I	P	C	P	R	T	J	P	E	G
			N	O		O	K		O	K		



if fi-434PR(IMPRINTER), IPC4D(IMAGE PROCESSING CIRCUIT BOARD) and fi-CMP3(JPEG COMPRESSION BOARD) are installed,Screen 27 will appear.

Screen 27

!	1	0	I	P	C	P	R	T	J	P	E	G
			I	P	C	-	4	D	O	K	O	K



2. Press **Exit** to return.

## 11 Low Power Mode Setting

1. Press "Next"  or "Previous"  and let the scanner display Screen 28.

Screen 28

!	1	3	P	o	w	e	r	S	a	v	e
=	1	0	1	5	2	0	m	i	n		



2. At Screen 28, press  or  to select the time duration. A minimum of 5 min to the maximum of 60 minutes can be selected. Then press **Enter** to activate the setting.

### NOTICE

The default time recommended by the ENERGYSTAR® program is 15 minutes. The default for the fi-4340C scanner is 15 minutes, as recommended.

3. Press **Exit** to return.

## 12 Select Interface



1. Press “Next”  or “Previous”  and let the scanner display Screen 29.

Screen 29

```
! 1 4   I n t e r f a c e
= A u t o / S C S I / T P S
```

### NOTICE

The Screen 29 will appear only when the scanner has proper interface boards or option boards in the third party slot.



2. At Screen 29, press  or  to select the interface type. Press  if you want to change the setting.

### NOTICE

1. Normally, this setting does not have to be changed.
2. When an appropriate board is installed in the third party slot of the scanner, the scanner automatically turns off the SCSI interface, activating the board in the third party slot. Screen 54 can be used to forcibly change the selected interface. The selected interface is then forcibly changed.
3. The SCSI interface and the board installed in the third party slot cannot be used at the same time.
4. The default is Auto.

3. Press  to return.

## 13 Display the TPS Board ID Number

1. Press “Next”  or “Previous”  and let the scanner display Screen 30.

Screen 30

```
! 1 5   T P S   B o a r d
      I n t e r f a c e   I D = 0
```



The scanner displays the ID number if the applicable board is installed.

### NOTICE

If the Fujitsu video Interface Option board is installed properly, the display shows “ID=7”.



2. Press  to return.

## 14 Select Built-In/IPC-4D Image Processing

1. Press “Next”  or  and let the scanner display the Screen 31.

Screen 31

!	1	6	I	P	C	M	o	d	e						
	S	t	a	n	d	e	r	d	/	I	P	C	-	4	D

2. At Screen 31, press  or  to select “Standard” or “IPC4D”.

When “Standard” is selected, the scanner uses its built-in image processing. On the other hand, the scanner selects the image processing of the IPC-4D (IMAGE PROCESSING CIRCUIT BOARD) when the “IPC-4D” is installed and selected.

### NOTICE

The factory default is “Standard”.



### NOTICE

fi-4340C has built-in Image Processing. The following image processing is supported both by the fi-4340C and the IPC-4D (IMAGE PROCESSING CIRCUIT BOARD). As a default, the scanner built-in functions are enabled. By setting "On" using the Operator Panel, the IPC-4D image processing overrides the built-in functions.

	Image Processing	IPC-4D	fi-4340C
1	Emphasis/Smoothing	5 x 5 matrix	3 x 3 matrix
2	Outline	Pre-threshold Laplacian	Laplacian
3	Simplified Dynamic Threshold	IPC-2 like SDTC	3 x 3 max-min

The IPC-4D (IMAGE PROCESSING CIRCUIT BOARD) support of those functions is intended for compatibility with the IPC-3/3D (except for image quality). The matrix size used in the IPC-4D (IMAGE PROCESSING CIRCUIT BOARD) is larger than the one in the fi-4340C. The fi-4340C Built-in Dynamic Threshold is a new algorithm.

## 15 Adjust ADF Erasing Edges

1. Press “Next”  or “Previous”  and let the scanner display Screen 32.

Screen 32

!	1	7	A	D	F	E	d	g	e	E	R	S	
	C	h	a	n	g	e	?	N	o	/	Y	e	s

2. At Screen 32, press  $\diamond$  or  $\diamond$  to select “Yes” and press **Enter**. Then the scanner displays Screen 33.

Screen 33

```
! 1 7 - 1   D e f a u l t ?  
           N o / Y e s
```

3. At Screen 33, select “Yes” to return the settings to the factory default or select “No” to make new settings (as shown below). Then press **Enter**. The scanner displays Screen 34.

Screen 34

```
! 1 7 - 2   A D F   T o p  
T o p =    0 m m
```

4. At Screen 34, press  $\diamond$  or  $\diamond$  to change the top setting. The value changes in 1 mm units. Then press **Enter** to activate the setting. The scanner displays Screen 35.

Screen 35

```
! 1 7 - 3   A D F   B o t t o m  
B t m =    0 m m ( + : U p )
```

5. At Screen 35, press  $\diamond$  or  $\diamond$  to change the bottom setting. With (+:Up), the area is set upward from the bottom edge of the image. With (-:Down), the area is set downward from the bottom edge of the image. The value changes in 1 mm units. Then press **Enter** to activate the setting. The scanner displays Screen 36.

Screen 36

```
! 1 7 - 4   A D F   L e f t  
L e f t =   0 m m
```



6. At Screen 36, press  $\diamond$  or  $\diamond$  to change the left setting. The value changes in 1 mm units. Then press **Enter** to activate the setting. The scanner displays Screen 37.

Screen 37

```
! 1 7 - 5   A D F   R i g h t  
R i g h t =   0 m m
```



7. At Screen 37, press  $\diamond$  or  $\diamond$  to change the top setting. The value changes in 1 mm units. Then press **Enter** to activate the setting. The scanner displays the next setup item.

## 16 Adjust FB Erasing Edges

1. Press “Next”  or “Previous”  and let the scanner display Screen 38.

Screen 38

!	1	8	F	B	E	d	g	e	E	R	S	
C	h	a	n	g	e	?	N	o	/	Y	e	s

2. At Screen 38, press  or  to select “Yes” and press . Then the scanner displays Screen 39.



Screen 39

!	1	8	-	1	D	e	f	a	u	l	t	?
					N	o	/	Y	e	s		

3. At Screen 39, select “Yes” to return the settings to the factory default or select “No” to make new settings (as shown below). Then press . The scanner displays Screen 40.



Screen 40

!	1	8	-	2	F	B	T	o	p			
T	o	p	=	0	m	m						

4. At Screen 40, press  or  to change the top setting. The value changes in 1 mm units. Then press  to activate the setting. The scanner displays Screen 41.



Screen 41

!	1	8	-	3	F	B	B	o	t	t	m	
B	t	m	=	0	m	m	(	+	:	U	p	)

5. At Screen 41, press  or  to change the bottom setting. With (+:Up), the area is set upward from the bottom edge of the image. With (–:Down), the area is set downward from the bottom edge of the image. The value changes in 1 mm units. Then press  to activate the setting. The scanner displays Screen 42.

Screen 42



!	1	8	-	4	F	B	L	e	f	t		
L	e	f	t	=	0	m	m					

6. At Screen 42, press  or  to change the left setting. The value changes in 1 mm units. Then press  to activate the setting. The scanner displays Screen 43.



Screen 43

!	1	8	-	5	F	B	R	i	g	h	t	
R	i	g	h	t	=	0	m	m				





- At Screen 43, press  or  to change the top setting. The value changes in 1 mm units. Then press  to activate the setting. The scanner displays the next setup item.

## 17 Color to be Read in Unicolor Reading

- Press "Next"  or "Previous"  and let the scanner display Screen 44.

Screen 44



!	1	9	R	e	a	d	C	o	l	o	r
=	R	/	G	/	B	/	W				

- At Screen 44, press  or  to select a light source. Press  if you want to activate the setting.

### NOTICES



- The specification from the host computer has priority.
  - The default is G (Green).
- Press  to return.

## 18 Setting the Grayscale Mode

- Press "Next"  or "Previous"  to display Screen 45 on the LCD.

Screen 45

!	2	0	G	r	a	y	M	o	d	e	
=	N	o	r	m	a	l	/	F	a	s	t

- In Screen 45, press  or  to select "Normal", "Fast" or "Fine".

"Normal" refers to the regular mode. When "Normal" is selected, scanning is performed at the machine defaults for image quality and speed.

"Fast" refers to the speed priority mode. When "Fast" is selected, scanning is performed at a speed faster than that of the normal mode.

"Fine" refers to the quality priority mode. When "Fine" is selected, scanning is performed at a quality higher than that of the normal mode.

The lower display of Screen 45 is switched as follows:

- "Normal/Fast" is displayed, and "Normal" flashes.
- "Fast/Fine" is displayed, and "Fast" flashes.
- "Fast/Fine" is displayed, and "Fine" flashes.

Switch between the above states as follows:

Press  $\diamond$  : The lower display of Screen 45 is switched cyclically in order from 3 to 1.

Press  $\diamond$  : The lower display of Screen 45 is switched cyclically in order from 1 to 3.

The relationship between speed and image quality is as follows:

Speed: 2 > 1 > 3

Image quality: 3 > 1 > 2

Changing this mode does not affect color and black-and-white scanning.

3. Then press  to activate the setting. The scanner displays the next item of the setup mode.

## 19 Reset of the Ink Remain Counter

The ink remain counter checks the service life of the print cartridge and makes a message "Please a new Ink" to prompt you to prepare a new ink cartridge. When the imprinter cannot print any more, replace the print cartridge and reset the Ink remain counter as follows. You must reset the ink remain counter even if you replace the print cartridge before its service life.

1. Press "Next"  $\diamond$  or "Previous"  $\diamond$  and let the scanner display Screen 46. First, "No" blinks.

Screen 46

!	2	1		I	n	k		r	e	m	a	i	n		
=	■	□	□	□	□	□		R	e	s	e	t	/	N	o

2. press  $\diamond$ , then "Reser" blinks. (Screen 47).

Screen 47

!	2	1		I	n	k		r	e	m	a	i	n		
=	■	□	□	□	□	□		R	e	s	e	t	/	N	o

3. Press . The reset execution screen appears. First, "No" blinks. (Screen 48)

Screen 48

!	2	1	-	1		R	e	s	e	t		N	o	w			
												N	o	/	Y	e	s

4. Press  $\diamond$ , then "Yes" blinks. (Screen 49)

Screen 49

!	2	1	-	1		R	e	s	e	t		N	o	w			
												N	o	/	Y	e	s

- Press **Enter** to perform reset operation. The ink remain indicator returns to ■■■■■■. (Screen 50)

Screen 50

!	2	1		I	n	k		r	e	m	a	i	n		
=	■	■	■	■	■	■		R	e	s	e	t	/	N	o



- Press **Exit**. The LCD returns to the “Ready” screen.

Screen 51

										X	X	X	X	
R	e	a	d	y				X	X	X	X	X	0	>



## 20 Setting the Numbering Print Function(for fi-434PR Imprinter Option)

You can specify conditions of the numbering print function from the operator panel when the scanner is equipped with the fi-434PR imprinter. The numbering counter increments 1 each a sheet of paper is read. Numbering print starts with a top margin of 7mm.

- Press “Next”  or “Previous”  and let the scanner display Screen 52.

Screen 52

!	2	2		N	u	m	b	e	r	i	n	g
=				O	n	/	O	f	f			

- At Screen 52, press  or  to select “On” then Press **Enter** if you want to activate the setting function. The scanner displays Screen 53, indicating that the setting function is activated.

Screen 53



!	2	2		N	u	m	b	e	r	i	n	g
=				H	o	s	t					

### NOTICE

When the setting function is disabled, the Screen 54.

Screen 54

!	2	2	-	1		D	i	g	i	t	s
=				5	/	8					

- At Screen 53, select the number of digits. press  or  to select “5” or “8” then press **Enter**. the scanner displays Screen 55.

Screen 55

!	2	2	-	2		S	t	a	r	t		C	o	u	n	t
=				0	0	0	0	0	0	0	0	0				

- At Screen 55,select the initial number.Press  $\diamond$  or  $\diamond$  to move the place of the blinking (changeable) digit and press  $\diamond$  or  $\diamond$  to change the value, than press  . The scanner displays Screen 56

Screen 56

!	2	2	-	3	E	m	p	t	y	R	e	s	e	t
=					O	n	/	O	f	f				

 **NOTICE**

The possible maximum number is 99999 (for five digits) or 16777215 (for eight digits).

- At Screen 56,specify whether the number is initialized at hopper empty.Press  $\diamond$  or  $\diamond$  to select “On” if you want to initialize, than press  . The scanner displays Screen 57

Screen 57

!	2	2	-	4	R	e	s	e	t	?
					N	o	/	Y	e	s

- At Screen 57,specify whether the number is reset at once.Press  $\diamond$  or  $\diamond$  to select “yes” if you want to reset at once, than press  . The scanner terminates the setup mode.

 **NOTICE**

The command from the host computer overrides the specification of the operator panel.When the host computer issues a command disabling the specification of the operator panel,Screen 57 does not appear.

# ***TROUBLESHOOTING***

---

*This chapter describes some potential problems and solutions that may occur when using this scanner.*

Troubleshooting .....8-2

# Troubleshooting

---

This chapter describes some potential problems and solutions that may occur when using this scanner. Should any of the following problems arise, refer to the relevant section listed below.

- Power doesn't turn on..... Refer to "Chapter 5-3 Cleaning & Maintenance"
- Operator Panel goes blank ..... Refer to "Chapter 5-4 Cleaning & Maintenance"
- Scan doesn't start ..... Refer to "Chapter 5-5 Cleaning & Maintenance"
- Image or photo scan output is poor ..... Refer to "Chapter 5-7 Cleaning & Maintenance"
- Text or line scan output is poor..... Refer to "Chapter 5-8 Cleaning & Maintenance"
- Scan image is distorted or unclear ..... Refer to "Chapter 5-9 Cleaning & Maintenance"
- Scan image is striped ..... Refer to "Chapter 5-10 Cleaning & Maintenance"
- "Check" LED turns on ..... Refer to "Chapter 5-11 Cleaning & Maintenance"
- "Clean pick roller" LCD message ..... Refer to "Chapter 5-12 Cleaning & Maintenance"
- "Clean ADF glass" LCD message ..... Refer to "Chapter 5-19 Cleaning & Maintenance"
- Frequent double-feeds..... Refer to "Chapter 5-14 Cleaning & Maintenance"
- Frequent pick-misses..... Refer to "Chapter 5-16 Cleaning & Maintenance"
- Frequent paper jams..... Refer to "Chapter 5-18 Cleaning & Maintenance"

## NOTICE

If the problem cannot be solved, contact your sales or service representative.

# ***CONSUMABLES AND OPTIONS***

---

*This chapter describes the consumables and options.*

<b>Consumables .....</b>	<b>9-2</b>
<b>Options .....</b>	<b>9-3</b>
<b>VIDEO INTERFACE BOARD.....</b>	<b>9-4</b>
<b>IPC-4D(IMAGE PROCESSING CIRCUIT BOARD).....</b>	<b>9-9</b>
<b>fi-434PR(IMPRINTER).....</b>	<b>9-10</b>
<b>fi-CMP3(JPEG COMPRESSION BOARD).....</b>	<b>9-11</b>

# Consumables

The following table lists consumables used for the scanner. Be sure to keep some consumables in stock. The customer is responsible for changing these items periodically, in accordance with the guidelines given below and in the “Cleaning and Maintenance” manual. If they are not changed as recommended, the scanner may not function properly. The abrasion counter can be used to check the total number of documents scanned since the last replacement(s).

Name	Specification	Remarks
Pad ASSY	PA03277-0002	Up to 100,000 sheets or one year.
Pick rollers	PA03277-0001	Up to 200,000 sheets or one year. (Two rollers are included.)

 **NOTICE**

Refer to the Cleaning and Maintenance guide for replacing the consumables.

 **CAUTION**

Certain paper types or conditions might reduce the life of consumables.



# Options

---

The following table lists options available for the scanner.

Product name	P/N
VIDEO INTERFACE BOARD	CA02956-2391
IPC-4D(IMAGE PROCESSING CIRCUIT BOARD)	CA02919-0521
fi-434PR(IMPRINTER)	PA03237-D104
fi-CMP3(JPEG COMPRESSION BOARD)	CA02956-2398

Contact your sales agent or PFU Limited and Fujitsu Group Offices for more information.

# VIDEO INTERFACE BOARD

## ■ How to Install the VIDEO INTERFACE BOARD

- 1** Loosen the two screws to remove the plate.

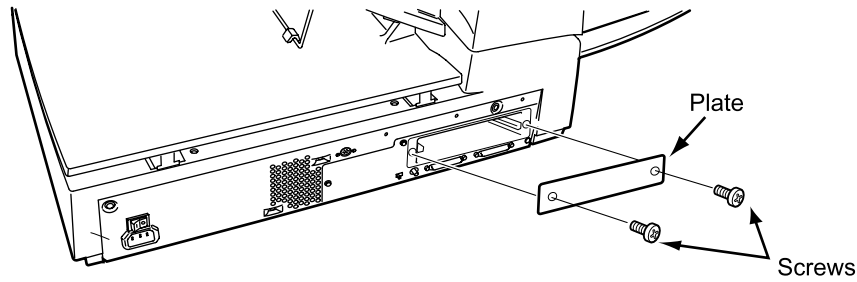

### CAUTION

Turn Off the power before removing the Third Party slot plate.

- 2** Insert the board along the rails of the third party slot. Make sure that the connector is connected securely.  
Secure the board with two screws.

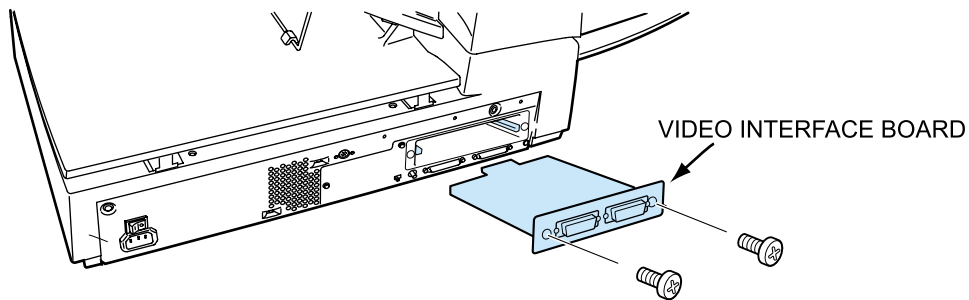

### CAUTION

Protective measures are required to prevent damage from static electricity.

### NOTICE

When the scanner power is turned On again, the scanner automatically recognizes the video interface board.

## ■ Reading Mode Setting When the VIDEO INTERFACE BOARD is Installed

This section describes the button specifications and setup details for reading modes when the scanner has the VIDEO INTERFACE BOARD in the third party slot.

When the reading mode is set by the command from the host computer, the following button operation is not required.

### NOTICE

When the VIDEO INTERFACE BOARD is installed in the scanner, the scanner automatically recognizes the board and changes the display.

Whenever you press **[Exit]**, the scanner returns to screen M1.

1. Turn the power On and verify that “Scanner Ready” is displayed on the LCD.

Screen M1

```

                                     X X X X
R e a d y           X X X X X 0 >

```

2. Press **[Next]** then the scanner displays Screen M2.

Screen M2

```

M o d e   S e l e c t   0
☐ R e a d i n g   M o d e

```

3. Press **[Enter]** then the scanner displays Screen 1.

Screen 1

```

☐ 0 1   I m a g e   S o r r c e
= A D F / F B

```

4. Select ADF or FB by pressing **◁** or **▷** then press **[Enter]**. The scanner displays Screen 2.

Screen 2

```

☐ 0 2   R e a d i n g   f a c e
= S i m p l e x / D u p l e x

```

5. Select “Simplex” or “Duplex” by pressing **◁** or **▷**. Then press Enter. The scanner displays Screen 3.

Screen 3

```

☐ 0 3   O r i e n t a t i o n
= P o r t / L a n d

```

6. Select "Portrait" or "Landscape" by pressing  $\diamond$  or  $\diamond$ . Then press **Enter**. The scanner displays Screen 4.

Screen 4

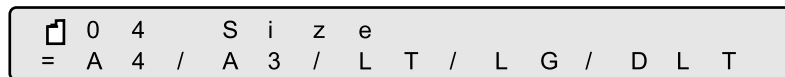

7. Select Size by pressing  $\diamond$  or  $\diamond$ . Then press **Enter**. The scanner displays Screen 5.

Screen 5

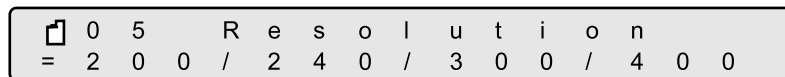

8. Select Resolution by pressing  $\diamond$  or  $\diamond$ . As the cursor moves to the left 100/150 may appear. Then press **Enter**. The scanner displays Screen 6.

Screen 6

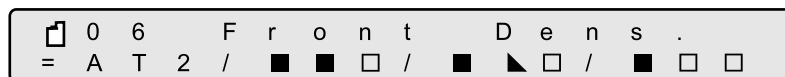

9. Select Front Density by pressing  $\diamond$  or  $\diamond$ . As the cursor moves to the right,  $\blacksquare \blacktriangle \square / \blacksquare \square \square$  may appear. Then press **Enter**. The scanner displays Screen 7.

Screen 7

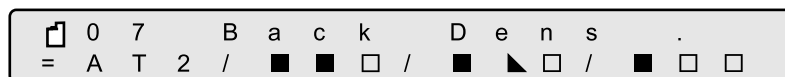

Density display

Without IPC-4D option	With IPC-4D option	Description
$\blacksquare \blacksquare \blacksquare$	$\blacksquare \blacksquare \blacksquare$	Very dark
$\blacksquare \blacksquare \blacktriangle$	$\blacksquare \blacksquare \blacktriangle$	Dark
	AT1 (*)	Dynamic Threshold (DTC mode)
	AT2 (*)	Simplified Dynamic Threshold (IPC mode)
$\blacksquare \blacksquare \square$	$\blacksquare \blacksquare \square$	Normal
$\blacksquare \blacktriangle \square$	$\blacksquare \blacktriangle \square$	Light
$\blacksquare \square \square$	$\blacksquare \square \square$	Very light

\*) This parameter appears only when IPC-4D (IMAGE PROCESSING CIRCUIT BOARD) is installed.

10. Select Back Density (when “Duplex” was Selected) by pressing  $\diamond$  or  $\diamond$ . As the cursor moves to the right,  $\blacksquare \blacktriangleright \square / \blacksquare \square \square$  may appear. Then press **Enter**. The scanner displays Screen 8.

Screen 8

```

  0 8   F . H a l f t o n e .
  = N o / H 1 / H 2 / L 1 / L 2
  
```

11. Select Front Halftone by pressing  $\diamond$  or  $\diamond$ .

Parameter	Description
No	Halftone is Off. Therefore binary reading is specified.
H1	Halftone with dither is specified.
H2	Halftone with error diffusion is specified.
L1 (*)	Automatic separation with dither is specified.
L2 (*)	Automatic separation with error diffusion is specified.

\*) This parameter appears only when the IPC-4D(IMAGE PROCESSING CIRCUIT BOARD) is installed.

Press **Enter** to confirm. The scanner displays Screen 9.

Screen 9

```

  0 9   B . H a l f t o n e .
  = N o / H 1 / H 2 / L 1 / L 2
  
```

12. Select Back Halftone (when “Duplex” was specified) by pressing  $\diamond$  or  $\diamond$ . The parameters are the same as in step 11. Press **Enter** to confirm. The scanner displays Screen 10.

Screen 10

```

  1 0   F o n t   D o c .
  = L i n e / P h o t o
  
```

13. Select Front Document Type by pressing  $\diamond$  or  $\diamond$ .

Parameter	Description
L. (Line)	White level following is ON. Top 3mm part of the document must be left blank (grounding color is drop-out color). Use this specification for reading line arts or texts.
P. (Photo)	White level following is Off. Use this specification for reading photographs.

Press **Enter** to confirm. The scanner displays Screen 11.

Screen 11

<input type="checkbox"/>	1	1	B	a	c	k	D	o	c	.
=	L	i	n	e	/	P	h	o	t	o

14. Select Back Document Type (when “Duplex” was specified) by pressing  $\diamond$  or  $\diamond$ . The parameters are the same as in step 13. Press **Enter** to confirm. The scanner displays Screen 12.

Screen 12(Example)

M	D	F	A	4	<input type="checkbox"/>	4	0	0	<input checked="" type="checkbox"/>	<input type="checkbox"/>	<input type="checkbox"/>	H	1	P
D	B	A	4	<input type="checkbox"/>	4	0	0	<input checked="" type="checkbox"/>	<input checked="" type="checkbox"/>	<input type="checkbox"/>	<input type="checkbox"/>	H	1	P

Resolution      Density      Line Art or Photo  
 Portrait  or Landscape       Halftone  
 Paper size  
 Front side(F) or Back side(B)  
 Simplex(S) or Duplex(D)

15. Confirm what you have specified.

If some parameter needs to change, press **Next** or **Previous** to select the corresponding screen and re-select the parameter by pressing  $\diamond$  or  $\diamond$  and finally press **Enter**.

If all parameters are acceptable, press **Exit** to return to the “Scanner Ready” screen.

# IPC-4D(IMAGE PROCESSING CIRCUIT BOARD)

The IPC-4D(IMAGE PROCESSING CIRCUIT BOARD) performs the image processing.  
IPC-4D(IMAGE PROCESSING CIRCUIT BOARD) supports the following image processing.

Item	Description
Pre-Filter	BallPoint Pen Mode : Smooth ballpoint pen strokes into a single bold line.
Background Removal	Remove background tone and light dither.
Dynamic Threshold	Dynamic Threshold: Automatically optimize binary threshold level to separate text from background, for high contrast output. IPC-2-like Dynamic Threshold: Optimizes the binary threshold level to separate text from background, allowing light text to be captured while maintaining sharpness.
Noise Removal	Dot removal size settable from 2x2 to 5x5. Optical noise (speckles, etc.) is automatically detected and removed from the output.
Auto Separation	Auto Separation : Automatically, detects the text area for binarizing and the photo area for dithering.
Outline Extract	Outline Extract outline of the image
Image Emphasys	Emphasis (Low/Middle/High/Smooth) : Emphasis contour.

## NOTICE

For the installation and functions of the IPC-4D(IMAGE PROCESSING CIRCUIT BOARD), refer to the supplied manual.

# fi-434PR(IMPRINTER)

The following table shows specifications of the fi-434PR(IMPRINTER).

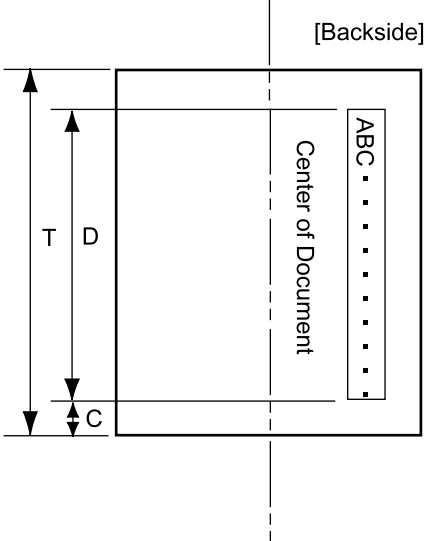
Item	Specification
Printing Method	Thermal inkjet printing
Printed Characters	Alphabet Letters : A to Z, a to z Numeric Characters : 0,1 to 9 Symbols : ! " # \$ % & ' ( ) * + , - . / : ; < = > ? @ [ ¥ ] ^ _ ' {   } ~
Maximum Number of Characters Printed	40
Character Size	Height 2.91 mm to width 2.82 mm
Character Pitch	About 3.53 mm
Printing Area	<p>The printable area of the backside of document is as follows:</p> <p>T Length of document  <math>D \leq 140.5\text{mm}</math> ( for 40 columns)  <math>C \geq 70.0\text{mm}</math></p> <p><math>T - (C + D) \geq 7\text{mm}</math></p>  <p style="text-align: right;">[Backside]</p>
Consumable	Print Cartridge (CA00050-0262)

 **NOTICE**

For the installation and functions of the fi-434PR(IMPRINTER), refer to the supplied manual.



## fi-CMP3(JPEG COMPRESSION BOARD)

The following table shows specifications of the fi-CMP3(JPEG COMPRESSION BOARD).

Item	Specification
Standard	Conforms to the ISO/IEC 10918-1 JPEG standard baseline process
Format	gray and multi-color images (JPEG)
Scan range	duplex A3/600 dpi, compression scans possible
Compressed Processing	Real time duplex compression processing
JPEG compression ratio	Built-in quantum table providing a 7 grade selection ranging from small compression rate (prioritizing image quality) to high compression rate (prioritizing size)
Other functions	Quantum table download function
Device	Slide-in type for easy installation

### ■ How to Install the fi-CMP3(JPEG COMPRESSION BOARD)

- 1 Loosen the two screws to remove the plate.

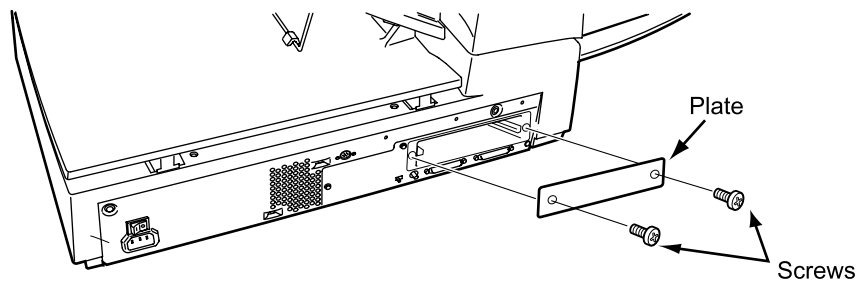

#### CAUTION

Turn Off the power before removing the Third Party slot plate.

- 2** Slide the fi-CMP3(JPEG COMPRESSION BOARD) fully into the option slot along it's internal rails, and fasten with the two screws provided.

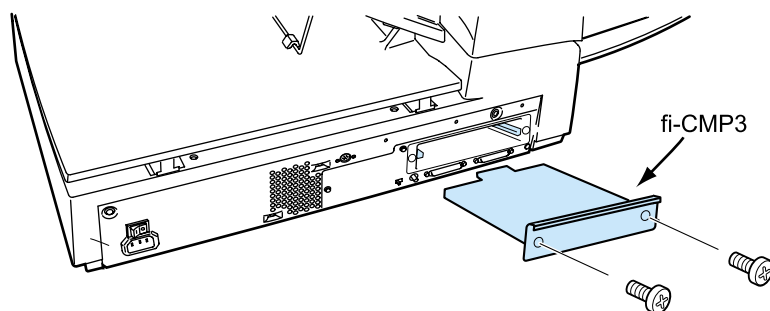

**CAUTION**

Protective measures are required to prevent damage from static electricity.

# SCANNER SPECIFICATIONS

---

*This chapter describes the basic product specifications, installation specifications, and dimensions.*

Basic Product Specification .....	10-2
Installation Specification .....	10-3
Dimensions .....	10-4

# Basic Product Specification

1	Scanner Type	ADF (Duplex), Document bed		
2	Image sensor	CCD x 2		Front/Back
3	Light source	White Xenon fluorescent tube x 2		Front/Back
4	Document Size	Minimum	A8 (Portrait)	
		Maximum	A4/Letter/Legal	
5	Paper Weight	52 g/m <sup>2</sup> (14 lb) to 127 g/m <sup>2</sup> (34 lb)		Note (*1)
6	Scanning Speed Note (*2)	Mono-chrome	40 pages/min simplex, 80 sides/min duplex (@200dpi)	Note (*3)
		Color	34 pages/min simplex, 48 sides/min duplex (@150dpi)	
7	ADF Capacity	100 sheets (A4, 64 g/m <sup>2</sup> (20 lb))		Note (*3)
8	Optical Resolution	600 dpi		
9	Output Resolution Note (*4)	Binary	50 - 800 dpi	Standard gradient is 1 dpi, (multiples are possible)
		Grayscale	50 - 600 dpi	Standard gradient is 1 dpi, (multiples are possible)
		Color	50 - 600 dpi	Standard gradient is 1 dpi, (multiples are possible)
10	Grayscale level (internal)	1024 levels (10 bits)		
11	Halftone Patterns	Dither/Error diffusion		
12	Other function	JPEG compression		Note (*5)
13	Interface Note (*6)	SCSI-2 (SE)		Shield-type 50 pin (pin-type) half-pitch
		Third Party Slot		Note (*7)

## NOTES

- \*1: The details are described in Chapter5 "ADF DOCUMENT SPECIFICATION".
- \*2) The scanning speeds given are the maximum mechanical scanning speeds. During actual scanning some extra time will be required for data transfer and software processing.
- \*3) The maximum number will differ due to the paper thickness. Refer to Chapter5 "ADF DOCUMENT SPECIFICATION".
- \*4) Maximum output resolution may vary according to the scan size, and setting (simplex/duplex)
- \*5) fi-475CMP3 (JPEG compression board) must be installed.
- \*6) Both SCSI-2 and the Third Party Slot can not be used at the same time.
- \*7) The Power consumption of the boards should be as follows:
  - In the Low Power Mode : Less than 0.35 A
  - Without IPC-4D(IMAGE PROCESSING CIRCUIT BOARD) : Less than 1.5 A
  - With IPC-4D(IMGGE PROCESSING CIRCUIT BOARD) : Less than 3.0 A

# Installation Specification

The following table lists the installation specifications of the scanner.

Item		Specification		
Dimensions (mm) (Without Hopper and Stacker)		Depth	Width	Height
		423 (16.6 in)	556 (21.9 in)	220 (8.7 in)
Weight (kg)		15 (48.4 lb.)		
Input power	Voltage	100 to 120 VAC $\pm$ 10 % or 220 to 240 VAC $\pm$ 10 %		
	Phases	Single-phase		
	Frequency	50/60 $\pm$ 3 Hz		
Power consumption		125 VA or less		
Ambient condition	Device status	Operating	Not operating	
	Temperature	5 to 35 °C (41 to 95 °F)	-20 to 60 °C (-4 to 140 °F)	
	Humidity	20 to 80 %	8 to 95 %	
Heat capacity		110 kcal/H (442 BTU/H)		
Shipping Weight (kg)		19 (41.9lb)		
Production Life		5 years or 2 million scans		

## NOTICE

The service life is estimated at 5 years after purchase or 2 million scans, whichever comes first. The cumulative number of scans are recorded by the Life Counter. For details on how to view the Life Counter display, refer to Chapter6 “Counter Display (page 6-2)”.

## NOTICE

Refer to the Cleaning and Maintenance guide for replacing the consumables.

# Dimensions

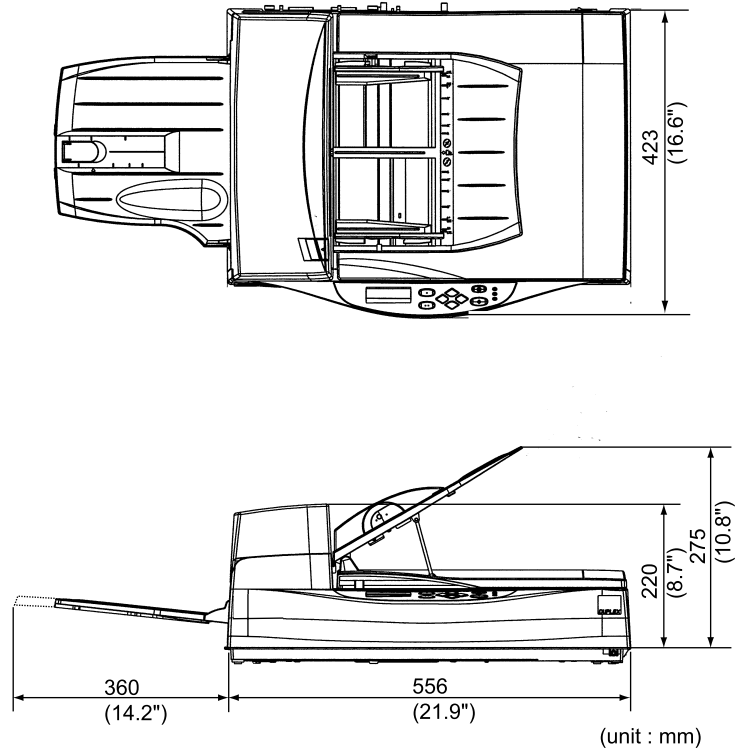

# ***GLOSSARY OF TERMS***

---

## **A4 size**

A standard paper size. Paper size is 210 x 297 mm.

## **A5 size**

A standard paper size. Paper size is 148 x 210 mm.

## **A6 size**

A standard paper size. Paper size is 105 x 148 mm.

## **A7 size**

A standard paper size. Paper size is 74 x 105 mm.

## **A8 size**

A standard paper size. Paper size is 53 x 74 mm.

## **Abrasion counter**

Counts the cumulative number of documents read to indicate when belts/rollers should be replaced. The number of read documents accumulates until an operator resets the counter. The counter should be reset when these consumables are replaced.

## **ASCII**

The acronym for American Standard Code for Information Interchange.

ASCII is a set of 256 codes (numbered 0 to 255) used to communicate information between a computer and another device such as a scanner.

## **Automatic separation**

An image processing method in which the scanner automatically detects difference between text and photos, and chooses the threshold accordingly. Automatic separation allows the scanner to switch between line mode and half tone mode in one pass.

## **Automatic start mode (<-> manual start mode)**

In this mode, the reading operation is activated only by issuing the START command.

## **Backside reading = Back-side scanning**

Refers to reading the backside of the document, specifically in Duplex reading mode.

## **Bit**

The smallest unit of information in computer memory. A bit is a single digit, either a 1 or a 0, in the binary numbering system. Eight bits equal one byte.

## **Density**

In this manual, refers to a measurement of the depth of the display.

## **Dither**

Technique for producing halftone images by representing the entire grayscale with only two pixel levels, black and white.

---

## **Double feed detection**

A scanner function which detects the accidental feeding of multiple sheets by the ADF unit. Can be turned on or off by the operator.

## **Double Letter Size**

A standard paper size used in the U.S.A. and other countries. Paper size is 11 x 17 inches.

## **dpi**

Dots per inch.

## **Dropout color**

A color which is used in the document but does not appear in the read image.

## **Duplex reading mode**

A reading mode in which both sides of the document are read.

## **Equipment Error**

An error that cannot be corrected by the operator. Call CE.

## **Error diffusion**

High-quality halftone (pseudo-grayscale) image production based on black-and-white pixel binarization. A pixel's optical density and that of adjacent pixels are summed, with black pixels relocated in their order of density as they relate to adjacent pixels.

The purpose of this technique is to minimize the average error between read and printed densities. Density data for adjacent pixels is modified by diffusing errors on the objective pixel into several pixels, which are then binarized. This maintains high grayscale levels and resolution during reading, while suppressing more patterns by dotted halftone images such as newspaper photographs.

## **FB**

In this manual, FB means flat bed.

## **Filtering**

A correction method that improves the read quality of handwritten documents. The read quality of images written in pencil or ball-pointed pen depends on the reflective light characteristics of the specific ink or lead used. Dropped pixels may produce outlines, gaps, or thin, barely connected lines due to uneven optical density. Filtering detects areas lighter than their surroundings and increases their density to improve image clarity.

## **Front-side reading = Front-side scanning**

Refers to reading the front side of the document, specifically in Duplex reading mode.

## **Halftone processing**

Any method used to reproduce a photograph which includes a shade as an image composed of dots, namely, a binary image. Dithering and error diffusion processing are examples of halftone processing.

## **Hexadecimal**

A base-16 numbering system (also commonly referred to as hex numbers). Since a base-16 system requires 16 digits, numbers 0 through 9 and letters A through F are used. It is convenient to express binary numbers in hexadecimal because fewer digits are required.



## **Image emphasis**

Density is decreased for lighter but not completely white areas adjacent to black areas. Weakening this emphasis eliminates spot noise or produces softened images.

## **Image processing**

An image is read with specified parameters.

## **Interface**

The connection that allows communication from one part of a system to another. For example, electrical signals are transferred between the computer and scanner over an interface cable.

## **Inversion (Reverse-image reading)**

In reverse-image reading, data is changed from black to white and vice versa.

## **IPC preset mode**

While reading binary images, it is necessary to set the scanner according to the quality of the sheet to be read. In this mode, these settings can be performed in advance by corresponding each setting to a pattern number.

## **IPC-4D**

Image processing option of this scanner.

## **IRAS**

Initialization of the hardware.

## **Landscape orientation**

A document is transported and read with the long side vertical to the moving direction.

## **Letter size**

A standard paper size used in the U.S.A. and other countries. Paper size is 8-1/2 x 11 inches.

## **Linedrawing mode**

Selecting linedrawing mode makes threshold and contrast settings effective but prevents brightness from being set. The specified threshold value determines whether black or white pixels are scanned. Line drawing mode is therefore appropriate for scanning text and line art images.

## **Manual Feed mode = Manual Mode**

Requires the operator to feed each document manually into the ADF paper chute.

## **Manual start mode (<-> automatic start mode)**

The reading operation is activated by pressing the START button in this mode. Available only when video option board is installed.

## **Mirror image**

The read image is symmetrically flipped to produce a mirror image of the original detected in the main scanning direction.

---

## Noise removal

Isolated noise from an image appearing as black spots in white areas and voids in black areas is removed to improve image quality.

## Operator panel

A panel containing the scanner indicators and buttons. The operator panel is used to control scanner operations such as loading document, selecting features, and changing setup options.

## Outline extraction

The boundary between black and white areas is traced and the outline extracted for closed areas.

## PAPER JAM

A warning informing the user that document is jammed in the transport unit, or that transportation is disabled because the transport unit is slippery. This warning also appears when a double feed is detected.

## Photograph mode (White level follower OFF)

Selecting photograph mode makes brightness and contrast settings effective but prevents the threshold from being set. With photograph mode, the darkness of image corresponds to the black-pixel density, making it suitable in scanning images such as photographs having gradations.

## Photo mode = photograph mode

A photograph is read properly in this mode.

## Pick start time

The period from the manual insertion of the document until picking starts after the document passes the hopper empty sensor.

## Portrait orientation

A document is transported and read with the long side parallel to the moving direction.

## Paper counter

Indicates the total number of read document from start of reading until the hopper becomes empty.

## Read operation

Refers to the reading operation including Simplex reading and Duplex reading.

## RS-232C interface

A type of serial interface. See Serial interface.

## SCSI-ID

Used to specify a particular SCSI device when the initiator selects a target or the target reconnects to the initiator.

## Serial interface

A standard computer interface. Information is transferred between devices over a single wire (although other wires are used for control).

With a serial interface, an interface cable greater than 3 meters (10 feet) can be used. This is often necessary in networking environments, where the scanner may be shared.

---

## **SETUP mode**

In this mode, users can view or set a variety of function in off-line.

## **Simplex reading mode**

Only the front side of the document is read in this mode. Place the documents face up at the center of the hopper table.

## **Smoothing**

A process that eliminates “jaggies” from slanted lines and curves. Irregular convexities are deleted and irregular concavities filled in. This is useful in OCR applications, for example.

## **Temporary Error**

An error correctable by the operator.

## **Terminator**

Devices with a SCSI interface can be daisy-chained. A resistor that includes terminal circuits needs to be placed at both ends of a cable when devices are daisy-chained. If a device (such as a scanner) is the last device in a chain, leaving an interface connector unused, a Terminator therefore must be attached to provide those terminal circuits.

## **Third Party Interface**

Optional board provided by Fujitsu or interface board provided by a third party can be installed and used.

## **Time-out limit**

This is the time the scanner waits for next document insertion after the last document feeding. The scanner returns Paper Empty when no document is set after time-out limit.

## **TPS**

Third Party Slot.



# INDEX

## A

- Abrasion counter..... 6-2
- Activating the Setup mode..... 7-2
- ADF..... 1-4
  - erasing edges ..... 7-14
  - lever ..... 1-4
  - mode..... 6-4
- Alarm ..... 6-5
- Ambient condition ..... 10-3
- Arrangement..... 1-6
- Assemblies ..... 1-5

## B

- Button/LED Function..... 1-7

## C

- Cable Connections ..... 2-4
- Checking the components ..... 1-2
- Confirm of the Manufacturing Labels.. 2-2
- Connecting
  - the interface cable ..... 2-4
- Consumables..... 9-2
- Contents of the Setup Mode ..... 7-3
- Conventions..... 1-viii

## D

- Density..... 9-6
- Dimensions ..... 10-3, 10-4
- Document
  - bed..... 1-4
  - holding pad ..... 1-4
  - Quality ..... 5-3
  - Size..... 5-2
  - type..... 4-6, 5-3
- Double
  - feed detection setting ..... 7-5, 7-6
  - feed error ..... 6-4
- Duplex reading mode..... 9-5

## E

- Enter button ..... 1-7

- Exit button..... 1-7

## F

- FB erasing edges ..... 7-16
- Feeding direction ..... 5-2

## G

- Grayscale mode setting..... 7-17

## H

- Halfone processing ..... 9-7
- Heat capacity ..... 10-3
- Hopper empty ..... 6-4

## I

- Image processing circuit..... 7-4, 7-14
- Input power..... 10-3
- Installation specifications..... 10-3
- Interface connectors ..... 1-4
- Interface select ..... 7-13
- IPC
  - mode select ..... 7-4, 7-14
  - preset mode setting..... 7-3, 7-7
  - status display..... 7-3, 7-11
- IPC-4D option ..... 7-14

## L

- Label
  - A ..... 2-2
  - B ..... 2-2
- Landscape orientation ..... 9-6
- LCD ..... 6-2
- LED..... 1-7
- Low power mode setting..... 7-12

## M

- Manual
  - feed mode ..... 4-4
  - start mode ..... 1-7

## N

Next button ..... 1-7

## O

Offset setting..... 7-3, 7-9  
Operation status..... 6-3  
Operator panel..... 1-6  
Option ..... 9-3, 9-4

## P

Pad Assembly ..... 9-2  
Paper  
    counter ..... 6-2  
    weight ..... 5-3  
Pick  
    roller ..... 9-2  
    start time setting ..... 7-3, 7-8  
Plain paper ..... 5-3  
Portrait ..... 9-6  
Power  
    consumption ..... 10-3  
    inlet ..... 1-4  
    switch ..... 1-4  
Precautions ..... 5-3  
Preface ..... 1-vii  
Previous button ..... 1-7

## R

Read Color..... 7-17  
Reading  
    face ..... 9-5  
    mode..... 9-5  
Resetting abrasion counter ..... 7-3, 7-8  
Resolution ..... 9-6

## S

SCSI terminator setting..... 7-12  
Select  
    interface ..... 7-13  
    IPC mode..... 7-14  
Setting  
    Display the TPS Board ID Number7-13

double feed detection

    paper length ..... 7-6  
    paper thickness ..... 7-5

Grayscale Mode ..... 7-17

Ink Remain Counter..... 7-18

Inprinter ..... 7-19

IPC preset mode..... 7-7

IPC Status Display..... 7-11

low power mode ..... 7-12

Numbering Print Function..... 7-19

Offset ..... 7-9

pick start time ..... 7-8

SCSI terminator ..... 7-12

time-out limit ..... 7-9

Unicolor Reading ..... 7-17

Setup mode ..... 7-2, 7-3

Simplex..... 9-5

Size..... 9-6

Specifications ..... 10-2, 10-3

Start button ..... 1-6, 1-7

Stop button ..... 1-6, 1-7

## T

Temporary error..... 6-4

Third party slot..... 1-4

Time-out limit setting ..... 7-9

TPS board ID number display ..... 7-13

Transport Lever ..... 2-3

Turning

    the power off..... 2-3

    the power on..... 4-2

## U

Unicolor Reading ..... 7-17

Units ..... 1-3

Units and Assemblies ..... 1-3

## W

Weight ..... 10-3

## Z

(Enter)button..... 1-7

---

(Exit)button .....	1-7
(Left Arrow Key)button.....	1-7
(Next)button.....	1-7
(Previous)button .....	1-7
(Right Arrow Key)button .....	1-7
(Send To)button.....	1-7
(Start)button.....	1-7
(Stop)button.....	1-7







FUJITSU